

Designing to **captivate**. Searching for **beauty in simplicity**. Simplicity that becomes **elegance**. Eliminating the superfluous. Focusing on the **exquisite** nature of the **details** that make an item **unique. Authentic. Exceptional.**

Designing merely for the satisfaction of a job well done. Of **high quality**.

Raising the expert hand of the **artisan**.

The hand which is seldom seen but always perceived. That's where its

value lies. Its **honesty**. Designing to

last. Transcending the volatility of passing trends with one's own

personality. Designing to **transform**

spaces. Bringing a touch of **exclusivity**,

whether subtle or bold, to make each room a space in which to experience

unforgettable moments. Designing to

be meaningful. To leave an imprint.

Respectfully, responsibly and positively.

At **RS Barcelona** we design with our soul, driven by passion.

A passion for design.

Diseñar para **seducir**. Buscar la belleza de la **sencillez**. Sencillez que se convierte en **elegancia**. Eliminar lo que sobra. Centrarse en lo **exquisito** de los **detalles** que lo hacen **único. Auténtico.**

Excepcional. Diseñar sin otra

pretensión que la del trabajo bien hecho. De **calidad**. Elevar la mano

experta del **artesano**. La que, en ocasiones, no se ve pero siempre se

percibe. Ahí radica su **valor**. Su

honestidad. Diseñar para **perdurar**.

Transcender a la volatilidad de las tendencias con su propia

personalidad. Diseñar para **transformar**

espacios. Aportar una nota de

exclusividad, sutil o atrevida, para hacer de cada estancia un lugar en el

que vivir momentos imborrables.

Diseñar para **significar**. Para dejar

huella. De forma **respetuosa, responsable y positiva**.

En **RS Barcelona** diseñamos con el alma por pasión.

Pasión por el diseño.

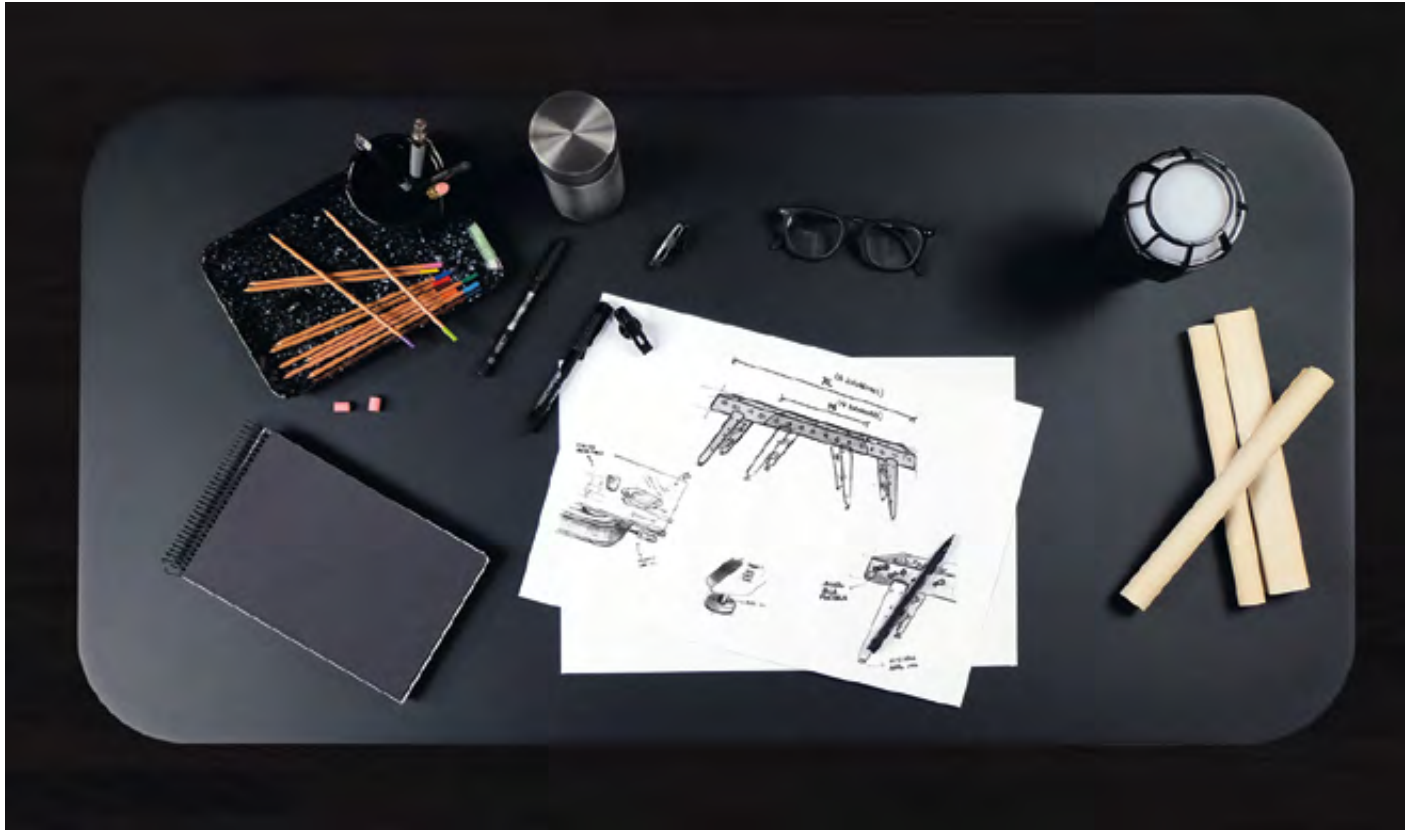

Design &

Inspiration • Inspiración	9
History • Historia	98
Creation • Creación	101
Bespoke • Personalización	103
Commitment • Compromiso	104
Values • Valores	106
Designers • Diseñadores	108
Products • Productos	110
Customisation • Customización	146
Colours • Colores	152
Quality • Calidad	154

This book is an interactive pdf.
You can jump directly to any chapter
by clicking on its title in the index.
And you can return to the index from any page by clicking
on the 'index' black button at the bottom of each page.

Este libro es un pdf interactivo.
Puedes saltar a cualquier capítulo
haciendo clic en el título del índice.
Y puedes volver al índice desde todas las páginas haciendo
clic en el botón negro 'índice' que encontrarás en la parte
inferior de cada página.



Show me, touch me, play me.

Diagonal Outdoor Pool Table · Yonoh

Diagonal is inspired by the perfect lines of the billiard game and by one of the main thoroughfares of Barcelona, the city where it's manufactured. And this is reflected in its design, in the simple forms and ingenious lines that give it a unique and timeless quality. Diagonal strikes the perfect balance between design and playability, and with its sleek and modern lines, it graces any outdoor setting.

Diagonal está inspirado en las líneas perfectas del juego del billar y en una de las calles que vertebraba Barcelona, la ciudad en la que se fabrica. Y eso se transmite en su diseño, en sus formas simples e ingeniosas que lo hacen único y atemporal. Diagonal consigue el equilibrio perfecto entre diseño y jugabilidad y, con sus líneas ligeras y modernas, luce en cualquier ambiente de exterior.



The sun and the stars
are up for the game.





Diagonal Top · Yonoh



Make the most of the Diagonal pool table with the top.



Experience your outdoor moments like never before.



Run the table.

Diagonal Indoor Pool Table · Yonoh

Just as a diagonal line crosses a space from end to end, the Diagonal pool table imbues any room with design, elegance and playful attitude. Its beauty emerges from its exquisite simplicity, the authenticity of its design and its blend of materials and colours. From sober black to bright white, striking red, subtle elegance of green or deep blue. Appeal for a game of precision and perfection.

Igual que una diagonal cruza un espacio de punta a punta, el billar Diagonal llena cualquier estancia de estilo, elegancia y actitud playful. Su belleza emana de su exquisita sencillez, la autenticidad de su diseño y su mezcla de materiales y colores. Desde la sobriedad del negro y la luminosidad del blanco, hasta la sensualidad del rojo y la elegancia informal del verde y el azul profundo. Poder de atracción para un juego de precisión y perfección.

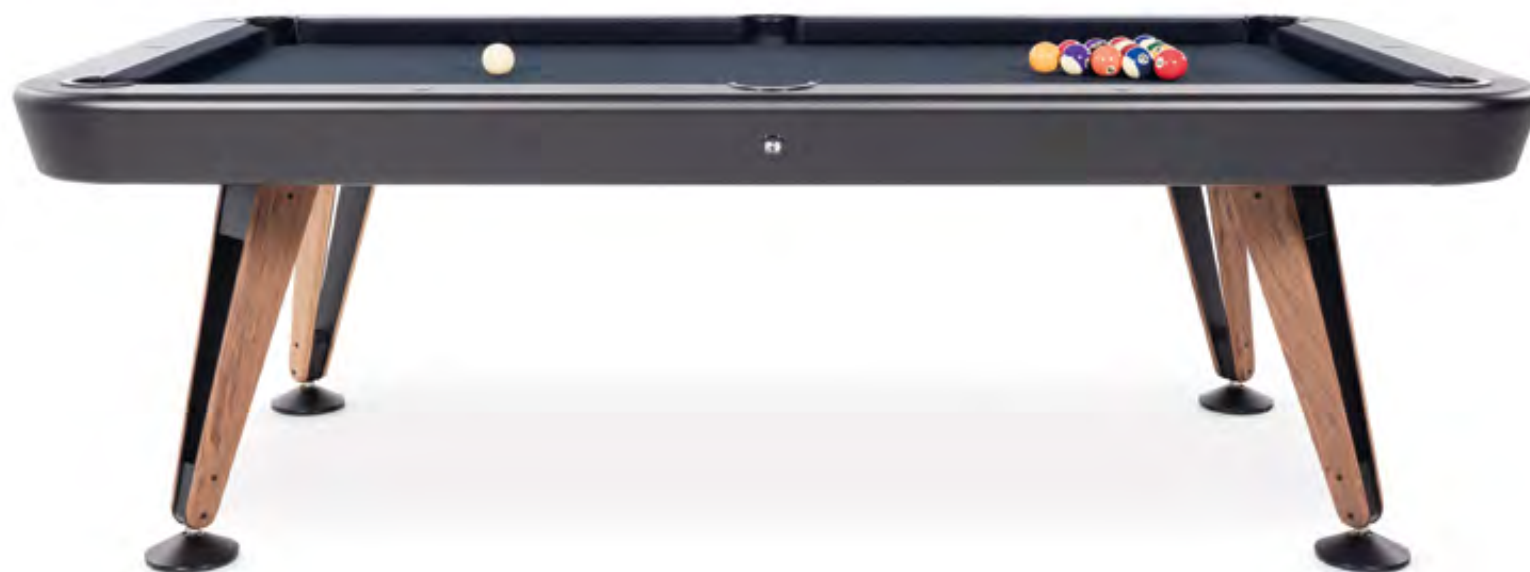





Harmony. Order.

Mou Floor Cue Rack · Yonoh

Mou and Diagonal play together as one. The Mou floor cue rack is the perfect mate for the Diagonal pool table. It keeps all your pool accessories safe in the same place. No more leaning pool cues against the wall. No more looking for chalk in every drawer. Each accessory has its own assigned space, and there's even room for other items such as music or drinks, so your pool game can really be a chance to unwind, get away from it all, concentrate on something different, while enjoying some company and the challenge of the game.

Mou y Diagonal bailan juntos en una coreografía de complicidad. El carrito Mou es el complemento perfecto para el billar Diagonal. Permite disponer de todos los accesorios del juego guardados y ordenados. Se acabó tener los tacos de billar apoyados contra la pared. No más buscar las tizas por todos los cajones. En el carrito Mou cada elemento tiene su espacio asignado, e incluso aún hay lugar para otros objetos como tu música o tus copas, y hacer de tu partida de billar una experiencia de auténtica desconexión, evasión, concentración, camaradería y reto.



Looking for perfection.

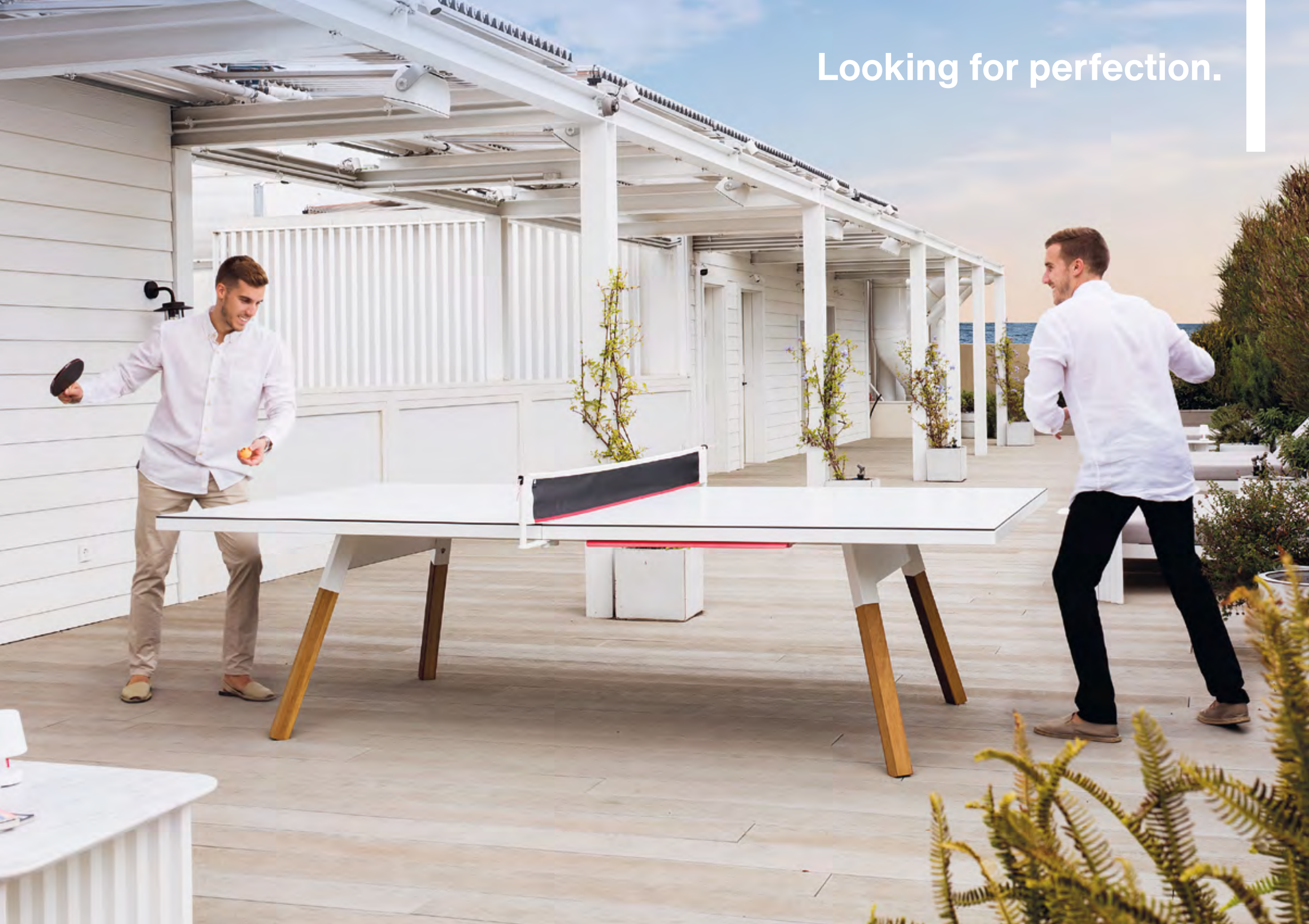

Love the game. Love the table.

You and Me Ping Pong Table · Antoni Pallejà Office

You and Me contains all the moments you can imagine. Working meetings; Monday breakfasts as the clock runs; a family barbecue on the weekend. And it goes without saying that there's plenty of time for many hours of playing too. You and Me is a ping pong table like you've never seen before, with sleek, minimalist lines that suits any interior but really comes into its own in outdoor settings. All the sporting elements- the net, the paddles and the balls -are stored in a discreet side drawer, completely out of sight. And the table is ready for any use you need.

You and Me contiene todos los momentos que puedas imaginar. Reuniones de trabajo; los desayunos acelerados de los lunes; la barbacoa familiar de domingo. Y, por supuesto, muchas partidas y horas de juego. You and Me es una mesa de ping-pong como no habías visto nunca, y con sus líneas mínimas encaja en cualquier ambiente en el interior y, aún mejor, también en el exterior. Toda la deportividad de la red, las palas y las bolas se guarda en un discreto cajón lateral y desaparece por completo. Lista para el uso que le quieras dar.



**An invitation
to enjoy life al fresco.**



7:55: Kids having breakfast under the relentless ticking of the clock.
 7:55: Niños desayunando bajo el tic-toc apremiante del reloj.



21:05: Dinner with friends with the whole evening ahead of you.
 21:05: Cena con amigos con la noche por delante.

14:20: 21-point family tournament while lunch is in the oven.
 14:20: Torneo familiar a 21 puntos mientras la comida coge su punto de sabor.

Improve your serve.





Get a grip!

RS Folding Ping Pong Table · Rafael Rodríguez

With the RS Folding, the sentence “I haven’t got space for a ping pong table” no longer makes sense. It breaks the mould. It restores design to its rightful place, combining the functionality of a folding ping pong table with our intense living design. It remains discreetly tucked away until it’s called into action, revealing all its charm. Once folded, by means of a simple mechanism, it takes up little space. And you can easily move it to the most convenient spot thanks to its tough all-terrain wheels. It will be waiting there for your next game.

Con el RS Folding la frase “No tengo espacio para un ping-pong” pierde todo su sentido. Rompe con todo lo preestablecido. Pone el diseño en el lugar que le corresponde y reúne en una misma mesa de ping-pong la funcionalidad del plegado y nuestro concepto de diseño *intense living*. Permanece discreta y escondida hasta que entra en acción y revela todo su atractivo. Una vez plegada, mediante un sencillo mecanismo, ocupa poco espacio, y puedes moverla fácilmente donde más te convenga, gracias a sus robustas ruedas todoterreno. Allí te esperará hasta la próxima partida.



Rule your ping pong world.



Play with confidence.

RS Stationary Ping Pong Table · Rafael Rodríguez

The RS Stationary ping pong table has real character. Its wooden legs give it strength and toughness. It invites you to play with no holds barred, to give it all, because you know that it can handle it. Without question, this is an all-terrain ping pong table. It was inspired by the idea of creating a playmate for the RS3 Wood, our wooden legged football table. They make a perfect couple, sharing outstanding design with strong lines and striking presence. But it has loads of personality in its own right. A ping pong table designed and manufactured for intense play. To last for as many matches as you can ever play.

RS Stationary es una mesa de ping-pong con carácter. Sus patas de madera le imprimen fuerza y resistencia. Invita a jugar sin reservas, a darlo todo, porque sabes que va a responder. Así es: un ping-pong todoterreno. Nació de la idea de crear el compañero de juegos para el RS3 Wood, nuestro fútbol con patas de madera. Juntos hacen un tándem perfecto. Comparten un diseño imponente, unas líneas firmes y una presencia indiscutible. Y, por separado, se hace valer con su arrolladora personalidad. Un ping-pong pensado y fabricado para el juego intenso. Para durar tantas partidas como seas capaz de jugar.



**We create fun games
that you'll love.**





Some days are simply meant for playing.

RS3 Wood Football Table · Rafael Rodríguez

The RS3 Wood is the natural progression of our determination to push the boundaries. We've incorporated wood in our football tables and the outcome is a warm and friendly, more contemporary design. The secret lies in the mix, in achieving the balance between the elements so that each one gives its best. We do not choose just any wood. The choice is iroko, a wood suitable for outdoors, that like metal, it's extremely durable and hardwearing, an essential requirement in our range of football tables. The essence remains intact, so you can enjoy the game without having to compromise on design.

RS3 Wood es la evolución natural de nuestro empeño por seguir probando e ir más allá. Introducimos la madera en nuestros futbolines y el resultado es un diseño cálido y cercano, más contemporáneo. El secreto está en saber mezclar, en alcanzar el equilibrio entre los elementos para que cada uno dé lo mejor de sí. No escogemos una madera cualquiera. La elegida es el iroko, una madera de exterior que comparte con el metal su gran resistencia y durabilidad. Dos requisitos fundamentales para formar parte de nuestro equipo de futbolines. La esencia sigue intacta para disfrutar del juego sin renunciar al diseño en una pieza nacida para vivir al exterior.



Go bigger to enjoy it
to the max.



The more the merrier.

RS Max Football Table · Rafael Rodríguez

Go big. Take it to the fullest. The RS Max football table shows that although two is company, three is not a crowd. And even eight is the perfect number to exploit the potential and personality of this football table. The RS Max is the long version of the RS3 Wood. We've resized it to double the fun, accommodating eight players instead of four, making it the ideal game for community spaces and group settings. More players. More laughter. More goals. More excitement.

A lo grande. Al máximo. El fútbol RS Max viene a demostrar que dos es compañía, tres no es multitud y todavía hay lugar para más. Ocho es un número redondo y la cifra perfecta para que este fútbol despliegue todo su potencial y su personalidad a lo grande. El RS Max es la versión alargada del RS3 Wood. Lo hemos redimensionado para duplicar la diversión y convertirlo en el juego perfecto para espacios comunitarios y colectividades. Más jugadores. Más risas. Más goles. Más emoción.



Game for food!







The icon. ██████████

RS2 Football Table · Rafael Rodríguez

The RS2 is “THE football table”. A spectacular reinterpretation of one of the all-time classics of Spanish game culture. This is where it all began. Our goal was to take the football table out of the garage and move it into the spaces where we do our living. We aimed for it to speak the language of design, dialogue with the furniture and seduce in any environment. A football table that highlights and makes the difference with its industrial design, sleek lines, elegant colours, exquisite details and its long lasting high quality finishes. It has stood the test of time and fleeting trends. Its design lasts and will remain as an iconic piece. For its design, its essence, its significance, and for all the moments that it captures.

RS2 es “EL fútbol”. Una espectacular reinterpretación de todo un clásico de nuestra cultura del juego. Con él empezó todo. Quisimos sacar el fútbol del garaje y trasladar el juego a los espacios más vividos. Que hablase el lenguaje del diseño y dialogase con el mobiliario. Que sedujese. Un fútbol que marcarse la diferencia con su diseño de estilo industrial, sus líneas y colores elegantes, con sus exquisitos detalles y sus materiales de alta calidad. Ha superado el paso del tiempo y las tendencias efímeras. Su diseño perdura y sigue siendo y será una pieza icónica. Por su diseño, su esencia, su significado, y por todos los momentos vividos que recoge.





Brilliance and eccentricity at
the table.



Eat. Play. Enjoy.

RS2 Dining Football Table

José Andrés & Rafael Rodríguez

An ingenious idea brought to life in which gastronomy, playtime and design go hand in hand at the most bizarre table in the restaurant. A collaboration with the well-known chef José Andrés, that was born from an idea as simple as original: We put a glass top over our iconic RS2 so it can be used as a dining table without having to stop the game. José Andrés fell in love with our football table and was keen to bring it into his culinary universe. His word was our command. What began as the customisation of our football table for his Jaleo restaurants in Washington and Las Vegas, a very eclectic and Spanish project, became a new piece in our collection.

“The RS2 Dining is an extra ingredient, a special touch in some of my restaurants,” says José Andrés.

RS2 Dining es toda una experiencia en la mesa. Una genialidad hecha realidad, en la que gastronomía, diseño y juego comparten la mesa más excéntrica del local. Una colaboración con el reconocido chef José Andrés que nace de una idea tan sencilla como original: añadimos un sobre de cristal a nuestro icónico RS2 para usarlo como mesa y futbolín a la vez. José Andrés se enamoró del futbolín y quiso incorporarlo a su universo culinario. Dicho y hecho. Y lo que comenzó siendo una personalización de uno de nuestros futbolines para sus restaurantes Jaleo de Washington y Las Vegas, un proyecto muy ecléctico y español, se convirtió en una nueva pieza de nuestra colección.

“La RS2 Dining es un ingrediente más, un toque especial en algunos de mis restaurantes”, dice José Andrés.





Dive into colours.

RS2 Football Table & RS2 Dining Football Table Rafael Rodríguez

Colours speak their own language beyond words. A universal language that stirs emotions and provokes feelings. Our new colour chart expresses timelessness and harmony. Colours that convey sophistication and refinement. That inspire with purity and sensuality. That enhance their presence subtly. That together they sum up and they gain in serenity and savoir-faire. Colours that highlight the beauty of our pieces.

Los colores hablan su propio lenguaje más allá de las palabras. Un lenguaje universal que arranca emociones y despierta sentimientos. Nuestra nueva paleta de colores habla de atemporalidad y armonía. Colores que transmiten sofisticación y sintonía. Que emocionan con su pureza y sensualidad. Que, con su sutileza, aportan presencia. Que juntos suman y combinados ganan en serenidad y saber estar. Colores que realzan la belleza y las formas de nuestras piezas.





The Gold Edition.

RS2 Gold Football Table · Rafael Rodríguez

Glamour and sophistication into the game. We dress our RS2 football table to the nines. In the Gold Edition, the players jump to the playing pitch with a chrome-plated kit in gold and silver and we add a subtle and elegant touch of brightness in gold colour to some details parts that have made these items all-time classics. It looks like pieces of art. Yes, it is. And, what's more, it is football table to be used and enjoyed as intensely as the rest of our range, but with that touch of sophistication you can expect to find in rarefied settings and ambiances. Because you can also play in a dinner suit or in an evening dress and high heels.

Glamour y sofisticación en el juego. El fútbol RS2 se viste de gala. En la Gold Edition, los jugadores salen al campo con traje dorado y plateado e introducimos un brillo sutil y elegante en oro a los detalles que han convertido estas piezas en clásicos. Parece una obra de arte. Lo es. Pero, por encima de todo, es un fútbol para jugar y disfrutar con la misma intensidad que el resto de la colección. Eso sí, con ese toque chic que respiran ciertos espacios y ambientes. Porque también se puede jugar a fútbol con frac, traje de noche y zapatos de aguja.

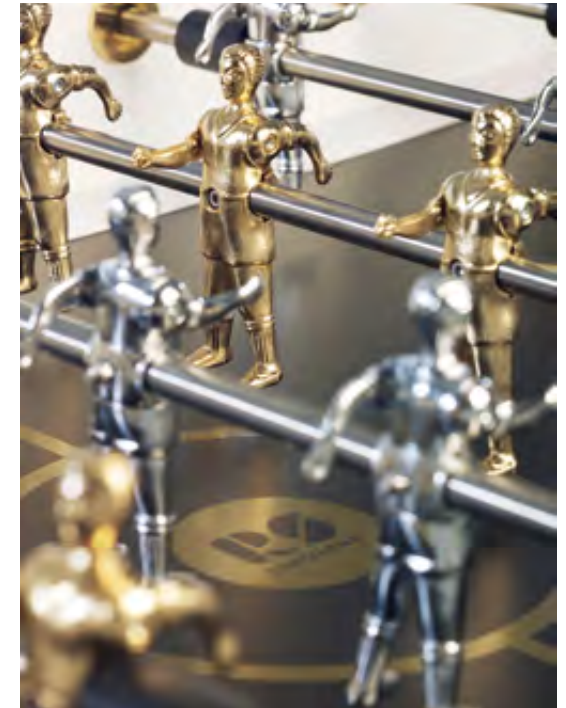





Pop art is for everyone.

RS3 Football Table · Rafael Rodríguez

It all begins with "Shall we have a game?" There are winners and losers, but everyone has a great time. Because playing is all about having fun and sharing time together. The RS3 football table injects colour into the game. Its look, with thin legs, is lighter and pop, but the steel structure bestows the same sensations and performances as our entire football table collection: playability, durability and design to enjoy it with the enthusiasm of a child but with the strength of an adult. Because the RS3 is for everyone and it's especially dedicated to all those children who at one time or another have said that "Adults don't play, they just work."

Todo empieza con "¿Echamos una partida?" A veces se gana. Otras se pierde. Aun así, todos se divierten. Porque jugar es compartir. El fútbol RS3 le da color a la partida. Su look, con patas finas, es más ligero y pop, pero su estructura en acero le confiere las mismas prestaciones y sensaciones que todos nuestros futbolines: jugabilidad, durabilidad y diseño para disfrutar como un niño con la potencia de un adulto. RS3 es para todos y está dedicado especialmente para esos niños que alguna vez han dicho eso de "los adultos no juegan, solo trabajan".





Ella. ██████████

Female Football Player

We have always believed in the power of sport as an instrument of cohesion and a link amongst people. Ella is more than just the first female football player. It's a statement of intent for gender equality. Ella was born under the hands of a craftsman who, with great dedication and affection, has carved it with the exact proportions as her male partner. The same skills and precise and powerful shots. The same desire to dribble, make through passes and score spectacular goals. On our football table pitch there are no differences. Ella and her mate play on an equal footing.

Siempre hemos creído en el poder del deporte como instrumento de cohesión y nexo de unión entra las personas. Ella es mucho más que la primera jugadora de fútbol. Es una declaración de intenciones. Nació de las manos de un escultor que, con dedicación y maestría, la talló con las proporciones de su compañero. La misma precisión y potencia de disparo. La misma resistencia y la misma pasión por marcar goles. En el terreno de juego de nuestros futbolines no hay diferencias. Ella y él juegan en las mismas condiciones.



Fill your home
with goals and laughter.

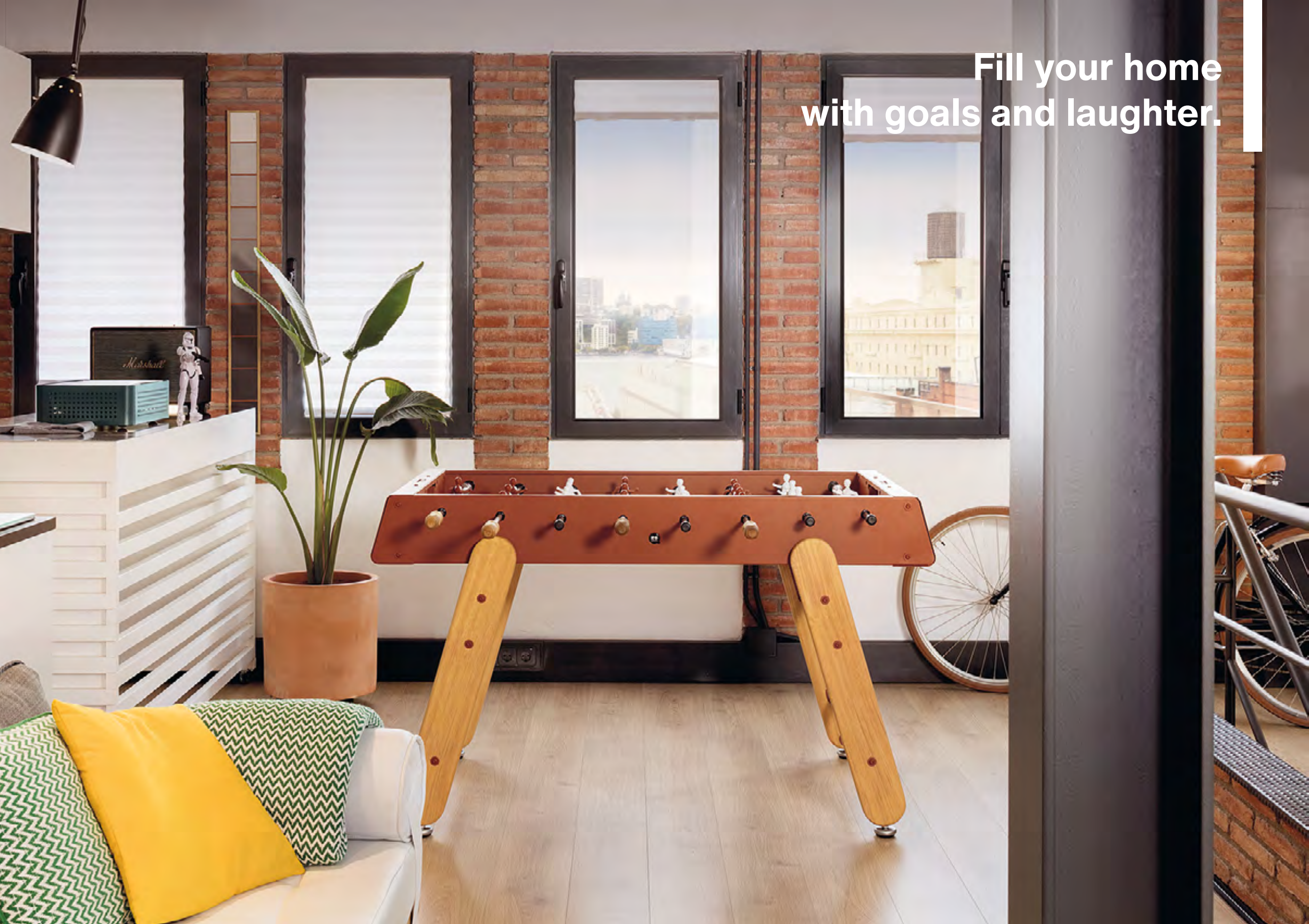



Do it yourself.

RS4 Home Football Table · Rafael Rodríguez

The RS4 Home football table has been designed to enjoy at home. For all ages. For sharing with anyone who dares to challenge you. For any moment. It comes with a manifesto in favour of real and authentic fun. Of playing as a family. Of switching off the TV, game console and mobiles to connect with friends. Of rediscovering the active games that make us leap and sweat with excitement. Of "do it yourself". Because putting it together, makes you love it even more. And when the match starts, you set the rules of the game.

The RS4 Home comes completely unassembled to optimise packaging, facilitate shipping and reduce environmental impact without giving up design, high quality and playability.

El fútbol RS4 Home ha sido diseñado para disfrutar en casa. Para todas las edades. Para compartir con todo aquel que se atreva a retarte. Para cualquier momento. Es un alegato a favor de recuperar la diversión auténtica y real. De apostar por el tiempo en familia. De apagar teles, consolas y móviles para conectar con los amigos. De volver al juego activo que nos hace movernos, saltar, sudar y emocionarnos. Del "hazlo tú mismo". Porque cuando lo montas, sientes que es más tuyo. Y cuando empiece el partido, tú marques las reglas del juego.

Viene completamente desmontado para optimizar el packaging, facilitar el envío y reducir el impacto ecológico. Sin renunciar al diseño, la calidad y la jugabilidad.



**The sensuality of the fold. The power of colour.
The pleasure of luxury in a fleshy bite.**

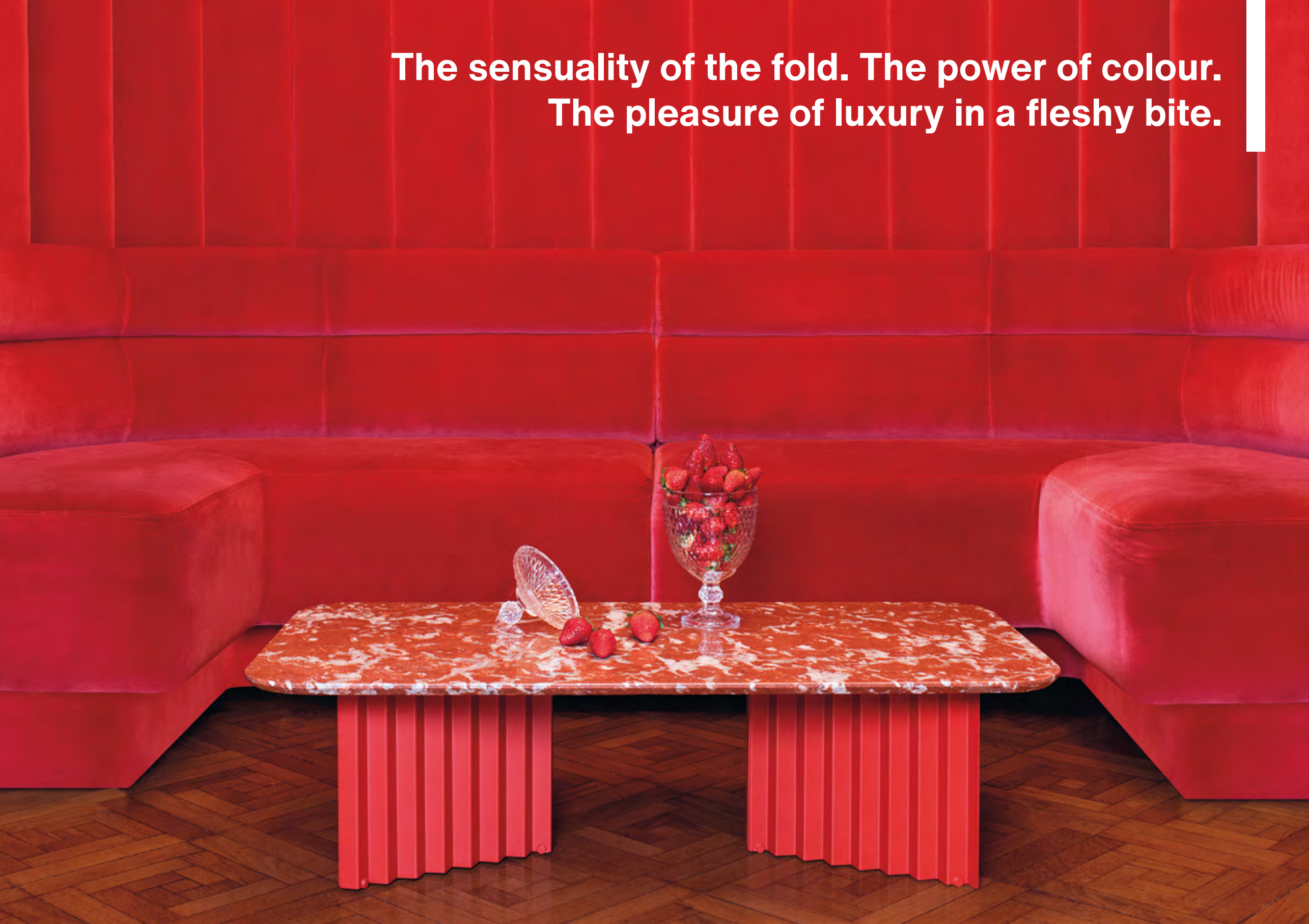



Reflections of perfection.

Plec Collection · Antoni Pallejà Office

Plec is a collection of tables that are as happy together as they are apart. With their accordion-shaped legs, they love creating light and shade effects with their symmetrical folds and sensual colours. Their sculptural design, which might seem classical at first, proves capable of adapting to every atmosphere. Metal gives them an industrial feel, and marble, the elegance and authenticity. Colours confer personality and uniqueness. And with the combination of these elements, Plec reveals its savoir-faire. Quiet and restrained presence, without raising its voice, but uncovering the beauty of perfection.

The Plec collection includes rectangular and round occasional tables, a desk and a pedestal.

Plec es una colección de mesas que se llevan bien tanto juntas como por separado. Con sus patas en forma de acordeón, juegan con la luz y crean efectos de luces y sombras con sus simétricos pliegues y sensuales colores. Su diseño escultural, que a simple vista podría parecer de estilo clásico, se adapta al entorno. El metal le confiere la fuerza y el look industrial y el mármol, la elegancia y la naturalidad. Su gama de colores, el carácter y la singularidad. Y con todos estos elementos, Plec muestra su saber estar. Su protagonismo comedido, sin alzar demasiado la voz, pero descubriendo la belleza de la perfección.

La colección Plec se compone de mesas de centro y auxiliares rectangulares y redondas, de un escritorio y un pedestal.





Life is around the table.



It's all about versatility.

B-Around Table · Antoni Pallejà Office

No two days are the same. No two projects are the same. No two meetings are the same. No two meals are the same. And no two B-Around tables are ever the same. Versatility is the word that best defines the B-Around table collection. Versatility in shape, size and height. Versatility in functionality: an office table, a conference table, a hot desk, a dining table, a kitchen table or a home desk. Versatility in place: for residential, offices, restaurants and hotels. Versatility in environment, both for indoors and outdoors. To eat. To celebrate. To meet. To work. To get together. B-Around is a table to live as you choose.

No hay dos días iguales. No hay dos proyectos iguales. Incluso no hay dos reuniones iguales. Ni dos comidas iguales. Y nunca dos mesas B-Around son iguales. Versatilidad es la palabra que mejor define a la colección de mesas B-Around. Versatilidad en sus formas, medidas y alturas. Versatilidad en funciones: como mesa de trabajo, de reuniones, hot desk, de comedor, de cocina o escritorio. Versatilidad en el espacio: para hogar, oficinas, restaurantes y hoteles. Versatilidad en ambiente: tanto en interior como exterior. Comer. Celebrar. Trabajar. Reunirse. Encontrarse. B-Around es una mesa para vivirla como elijas.





The right position.

Ombra Stool · Emiliana Design Studio

The Ombra stool shows itself as it truly and honestly is. It has nothing to hide. Its simple and clean shape is its own structure. Solid and resistant, with a comfortable, generous and ergonomic seat. It knows that the days are intense and the nights might be long. That's why it waits, discreet but alert for its time to come. Attentive to your conversations at the bar; accompanying you through hard work at the office; sharing a bite to eat on the terrace; waiting for dinner to be ready in the kitchen. It always has a place reserved for you. Get your Ombra and have a nice sit-down.

El taburete Ombra se muestra tal y como es. No tiene nada que ocultar. Sus formas sencillas y limpias son su propia estructura. Firme y resistente y con una sentada cómoda, generosa y ergonómica. Y es que sabe que los días son intensos y las noches se alargan. Por eso espera, discreto, pero alerta a que llegue su momento. Atento a tus conversaciones en la barra del bar; acompañándote en la oficina; compartiendo un bocado en la terraza; aguardando a que la cena esté lista en la cocina. Siempre tiene un sitio reservado para ti. Coge tu Ombra y toma asiento.



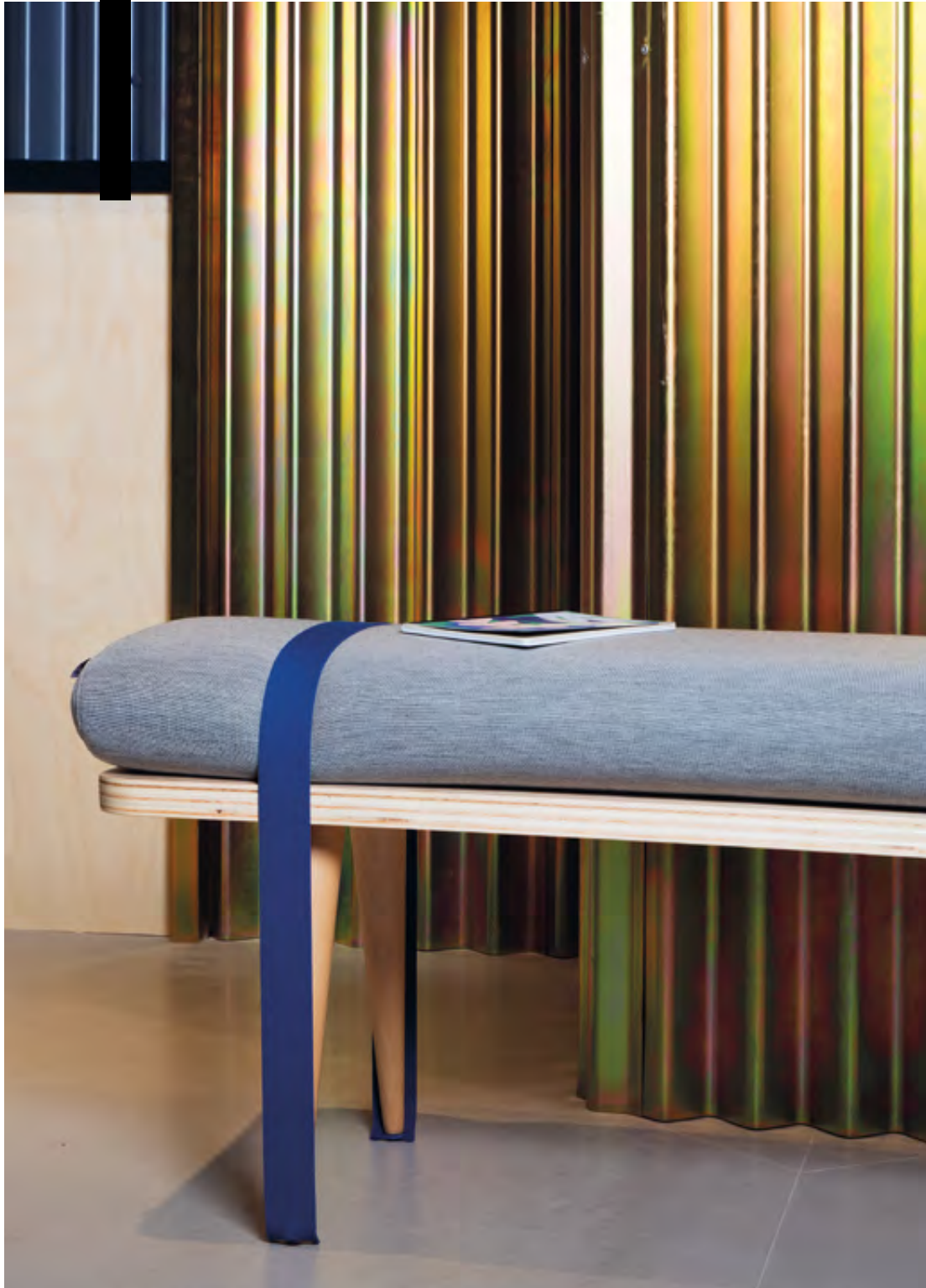

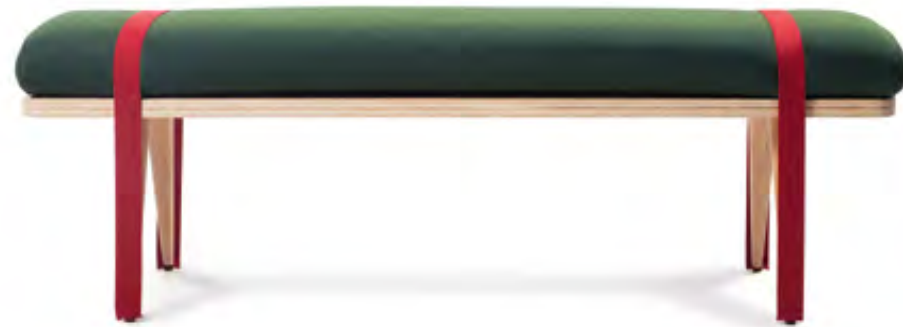

Simply beautiful.

On the road Bench · Stone Designs

The On the road bench isn't interested in anything showy or superfluous. Just being itself is all it needs to feel free and to instill its character and essence. It was inspired by a long motorcycle trip on Route 66. Perhaps that's why it prefers you to move it around and put it anywhere rather than treating it as a static, fixed piece of furniture. It prefers to move freely and bring its spontaneity, warmth and coziness to the space it lives in. Put it in your entrance hall, ready to greet you and help you take your shoes off and unwind for a while when you get home at the end of a stressful day. At the foot of your bed. In the middle of your dressing room. In the reception area of the hotel, for the comfort of guests as they come and go. Or in the office, for informal meetings or for resting in the downtime area. You won't be able to resist sitting down on its soft cushion and letting your mind be pulled towards the changing horizon of your own landscapes.

Al banco On the road no le van los adornos ni lo superfluo. Ser él mismo es todo lo que necesita para sentirse libre y transmitir su espíritu y su esencia. La inspiración llegó en un largo viaje en motocicleta por la Ruta 66. Quizás por eso te invita a ubicarlo en cualquier lugar y a no planteártelo como un elemento fijo ni estático. La monotonía no es para él. Le gusta moverse con libertad y llevar su naturalidad y calidez al espacio que habita. En la entrada de casa, listo para recibirte y ayudarte a quitarte los zapatos y el estrés acumulado. A los pies de tu cama. En el centro del vestidor. En la recepción del hotel, para acomodar a los clientes que vienen y van. O en la oficina, para reuniones informales y en zonas de descanso y desconexión. Porque su mullido cojín te provoca a sentarte y dejarte llevar al horizonte cambiante de tus propios paisajes.



**Tasty moments and
some tan lines.**





BBQ, simplified.

Mon Oncle Barbecue · Mermelada Estudio

The design of Mon Oncle has been a real challenge, a creative adventure. We adopted a fresh and original approach in order to turn an everyday item like a barbecue into something extraordinary. Closed, it's an elegant briefcase with character and a vintage feel. But it's a briefcase with a surprise, because when you open it up, it becomes a fully-functioning and hardwearing portable tabletop barbecue that stores very tasty moments and memories. It's an innovative design that goes beyond the traditional concept of grills to enjoy the flavour of charcoal-cooked meals at any time, in an informal and unplanned way, wherever good company takes you.

El diseño de Mon Oncle ha sido todo un reto, una aventura creativa, con una mirada fresca y original por convertir en especial algo tan cotidiano como una barbacoa. Cerrado, es un elegante maletín metálico de inspiración vintage. Un maletín con sorpresa. Pues, abierto, es una barbacoa de sobremesa portátil, resistente y muy funcional que guarda en su interior momentos muy apetitosos y recuerdos con muy buen sabor. Un diseño innovador que trasciende el concepto tradicional de las parrillas para disfrutar del aroma de los platos cocinados al carbón en cualquier momento, de forma improvisada, allá donde la buena compañía te lleve.



Hooked on a feeling.

Wall Champions Coat Rack · Rafael Rodríguez

Wall Champions is a coat rack that was born a footballer. The players of our classic football table have jumped from the pitch to the wall and taken the shape of a coat rack. A piece as useful as decorative and significant. Because in the football universe, colours mean passion. Players are fully customisable with the personality and exclusivity of hand-painted artwork. Male of female, skin tone, and of course, the uniform. Any team. From today or from the past. Make it yours and live your colours.

Wall Champions es un colgador que nació futbolista. Los jugadores de nuestros futbolines saltan del terreno de juego a la pared y toman la forma de un perchero. Una pieza funcional y decorativa a partes iguales y cargada de significado. Porque en el fútbol, los colores son pasión. Los jugadores son totalmente personalizables con la autenticidad del trabajo pintado a mano. Chicos, chicas, el tono de la piel, y por supuesto, la equipación. Cualquier equipo. De ahora o del pasado. Hazlo tuyo y vive tus colores.

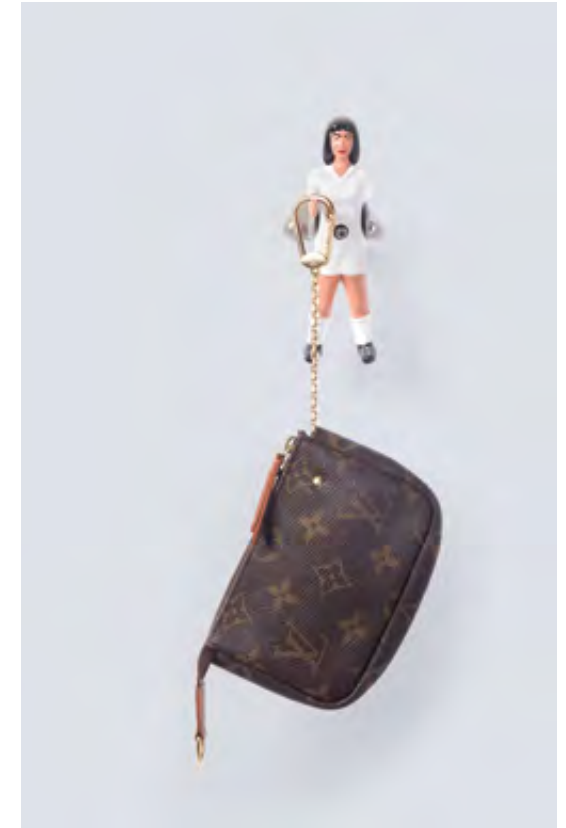
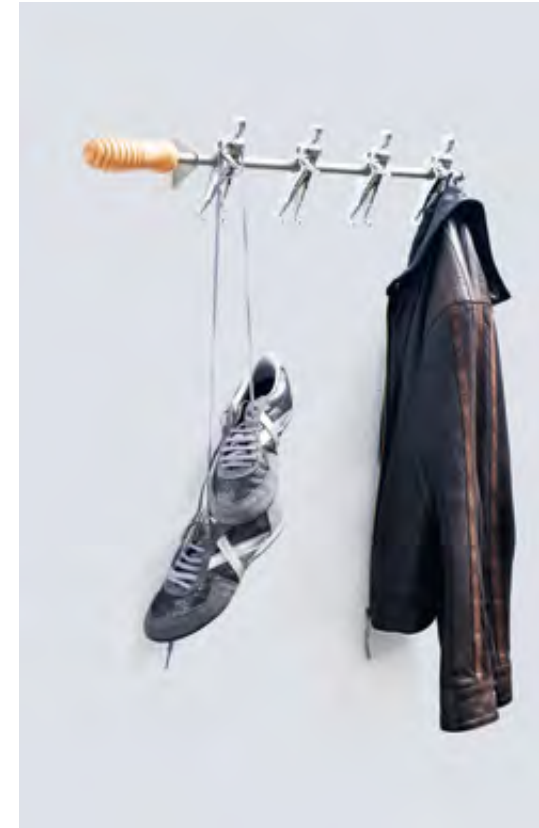

The wisdom of hands passed down the generations of a family with a metal soul.

The passion for a job well done, learnt at the side of a master craftsman.

La sabiduría de las manos transmitida de una generación a otra en una familia con alma de metal.

La pasión por el trabajo bien hecho aprendida al lado de un maestro del oficio.



Design & history



The history of RS Barcelona began in 1975 in a small sheet metal workshop. Rafael Rodríguez Castillo, a seasoned mould maker, decided to set up his own business. Over time, his workshop became an industrial building just outside Barcelona and his two sons, Rafael and Sergio, joined the business. The machines cut, folded and bent metal at a relentless pace and the work soon became monotonous. Working for others put food on the table but it didn't satisfy the creative hunger of the business. It was time for the company to put all the expertise built up over the years into designing a unique product of its own. An iconic design is born: the RS2 football table, taking the football table out of the garage and into the living room, the nerve centre of the home.

Coincidence came into play in 2006, when RS Barcelona came into contact with Vinçon, Barcelona's leading design store, and the RS2 earned itself a prime spot in the store window. This chance encounter gave the company the push it needed to reach for more. More dreams. More products. More progress.

That's how it all began, with a football table. But it wasn't just a product. It wasn't just a game. It was a statement of intent, the essence of intense living: a way to celebrate the beauty of life, inviting us to savour every moment.

That's what we've been doing for the last 15 years. Putting our soul and craftsmanship into everything we do to transmit our passion for design.

La historia de RS Barcelona arranca en 1975, en un pequeño taller de chapa metálica. Rafael Rodríguez Castillo, un matricero con mucho oficio a sus espaldas, decide montar su propio negocio. Con el tiempo, se convierte en una nave industrial a pocos kilómetros de Barcelona; un proyecto al que se unen sus dos hijos, Rafael y Sergio. Las máquinas cortan y doblan el metal a un ritmo incansable y constante que, pronto, se hace monótono. Y es que trabajar para otros da de comer, pero no sacia el apetito creativo. Con toda la experiencia del oficio en las manos se lanzan a diseñar un producto propio y único. Así nace el fútbolín RS2. Un diseño icónico que permite sacar el fútbolín del garaje para disfrutarlo en el salón, donde fluye la vida del hogar.

En 2006, la casualidad entra en juego cuando RS Barcelona y Vinçon, la tienda referente del diseño en Barcelona, se conocen y el RS2 se hace un hueco privilegiado en su escaparate. Ese encuentro fortuito les da la visibilidad y la proyección que necesitan para lanzarse a por más productos. Más sueños. Más lejos.

Así comienza todo: con un fútbolín. Pero no es un simple producto. No es solo un juego. Es toda una declaración de intenciones. Es su forma de entender el diseño y la esencia del *intense living*. Una manera de exaltar la belleza que reside en la vida y que nos invita a exprimir cada momento y saborearlo al máximo.

Eso es lo que venimos haciendo durante estos 15 años. Poner el alma y el oficio en todo lo que hacemos para compartir nuestra pasión por el diseño.



Design & creation

Our passion for attention to detail can be traced back to our roots. It forms part and parcel of our craft. We've come to know the soul of our craft through the expertise acquired over the last 40 years in handling and shaping materials. That's the beauty of a job well done, finding that magical moment when the attention to detail and the precision of a machine join forces to achieve excellence. Working in close collaboration with local professionals and manufacturers, we produce iconic items. Made by us. With our own hands. At our own facilities. Designs made in Barcelona.

El amor por el detalle surge de nuestras raíces. Es innato al oficio. Las manos expertas del artesano y la experiencia tras más de 40 años tocando y moldeando materiales nos permite conocer su alma. Esa es la belleza del trabajo bien hecho. Encontrar ese momento mágico en el que el detalle artesanal de siempre y la precisión de la máquina se unen para dar lo mejor de sí y alcanzar la excelencia. Y así, trabajando en estrecha colaboración con profesionales y productores locales, fabricamos piezas icónicas. Hechas por nosotros mismos. Con nuestras propias manos. En nuestras propias instalaciones. Diseños hechos en Barcelona.

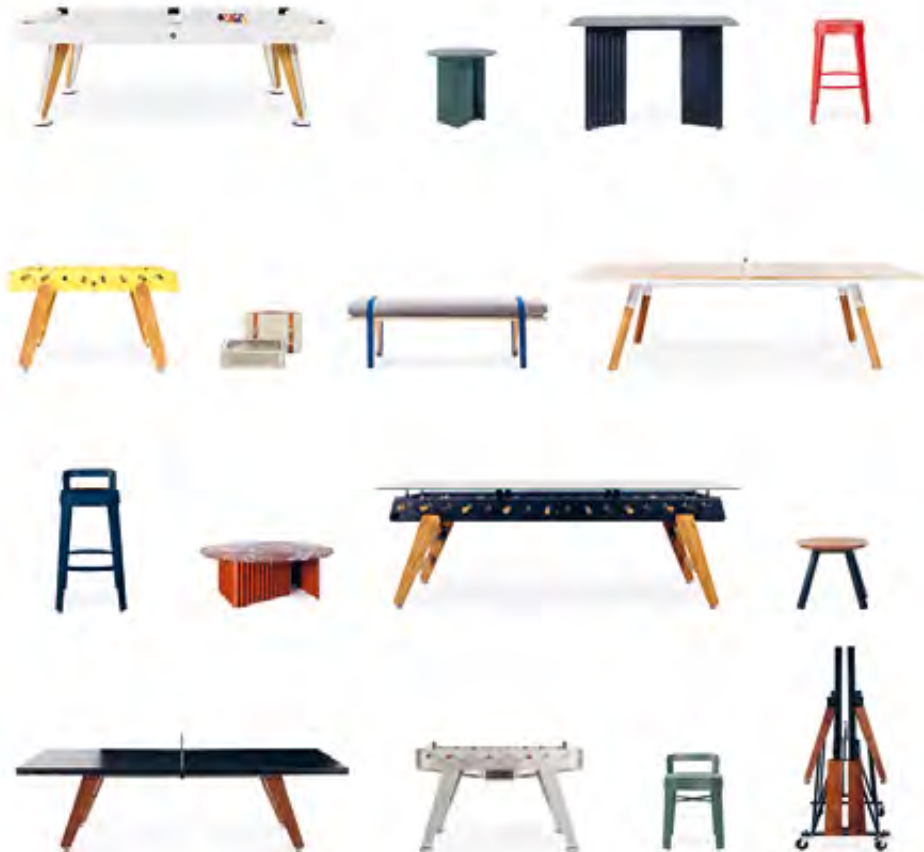

Design & bespoke

The luxury of finesse. Of the details that make the ordinary extraordinary. Those little special features that make an item exclusive. We trust in the power of collaboration to get the best out of ourselves. You know what you want. We bring our experience and boldness, incorporating those special touches in order to make the item even more special and personal. We meet the needs and demands of your projects and —why not?—your whims. Let's make your item unique, proudly displaying bespoke design.

El lujo de la sutileza. De los detalles que hacen lo ordinario extraordinario. Son esas pequeñas peculiaridades las que convierten una pieza en exclusiva. Confiamos en el poder de la colaboración para sacar lo mejor de cada uno de nosotros. Tú sabes lo que quieres. Nosotros aportamos nuestra experiencia y confianza para incorporar esas pinceladas que lo harán, si cabe, más especial y personal. Y, así, atender a las necesidades y las exigencias de tus proyectos y, por qué no, de tus caprichos. Hagámoslo único y luce diseño a medida.

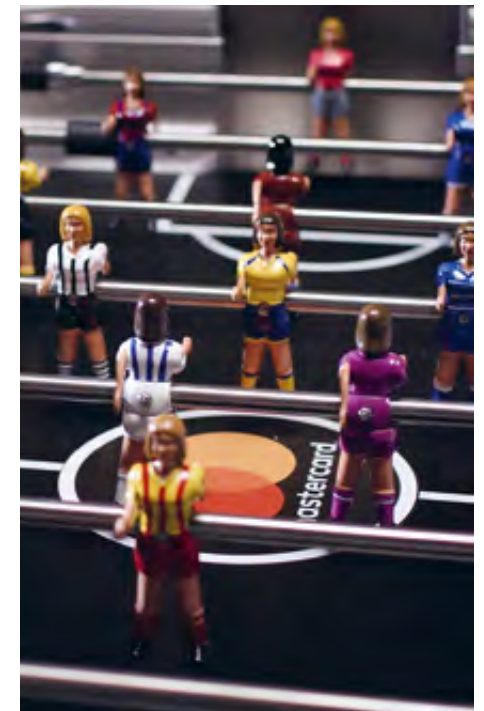

Design & commitment

Well aware that our actions have consequences, we're committed to designing and manufacturing in a sustainable manner, focused on people's wellbeing and respect for the environment. We manufacture ethically, using high-quality, long-lasting and recyclable materials to create timeless products that transcend passing fads. We're committed to local manufacturing and processes that reduce our environmental impact. We do this with the simple goal of living in a kinder, more respectful manner, and in order to feel proud of the imprint we leave behind.

"Our products are 98% recyclable."

Conscientes de que nuestros actos tienen consecuencias, nos comprometemos a diseñar y fabricar de forma sostenible, enfocados en el bienestar de las personas y el respeto por el medio ambiente. Producimos de forma ética, con materiales de alta calidad y reciclables, con los que proponer piezas que perduran, trascendiendo las modas pasajeras y superando la barrera del tiempo. Apostamos por la producción local y la fabricación mediante procesos que reducen nuestro impacto ecológico. Con la simple pretensión de vivir de una forma más respetuosa y amable y sentirnos orgullosos de la huella que dejamos atrás.

"Nuestros productos son reciclables en un 98%"

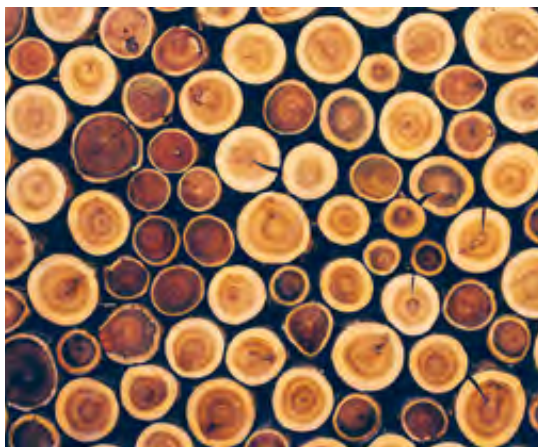

Design & values

At RS Barcelona we create designs capable of transforming spaces, pieces that fill the atmosphere with their high aesthetic value and magnetism. They're experiences. They're unforgettable moments. They're our way of interpreting our surroundings. They reflect a set of values that define how we design, manufacture, work, share and live.

En RS Barcelona creamos diseños capaces de transformar espacios. Piezas que con su alto valor estético y su magnetismo llenan el ambiente. Son experiencias. Son momentos inolvidables. Son nuestro modo de interpretar lo que nos rodea. El reflejo de unos valores que definen nuestra forma de diseñar, fabricar, trabajar, compartir y vivir.

Design

It's our essence. Design that goes beyond function and form, that inspires and excites, that captivates and wins over.

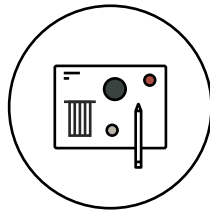

Diseño

Es nuestra esencia. Diseño que va más allá de la función y la forma. Que inspira y emociona. Que seduce y conquista.

Iconic

Authenticity that transcends trends and time, becoming exclusive and unique.

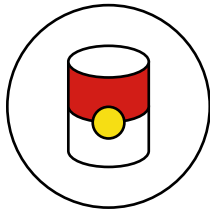

Icónico

Autenticidad que trasciende a las tendencias y al tiempo y se convierte en exclusivo y único.

Desire

Falling in love. Loving it to the point of needing it. Aspiration, a badge to be worn with pride.

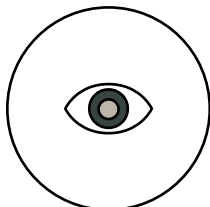

Deseo

Enamorarse. Quererlo hasta el punto de necesitarlo. Aspiración, distinción de la que presumir.

Quality

We're manufacturers. We control all the production processes. To ensure top quality down to the very last detail.

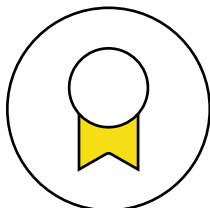

Calidad

Somos fabricantes. Controlamos todos los procesos de producción. Para que la calidad sea máxima en cada detalle.

Customer care

Quality beyond the product. Excellence in customer service and assistance, offering the perfect experience.

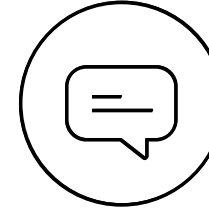

Atención al cliente

Calidad más allá del producto. Excelencia en la atención y el servicio, haciendo sublime la experiencia.

Customisation

Together we define your needs and expectations. And together we design a special product for you. No two are the same.

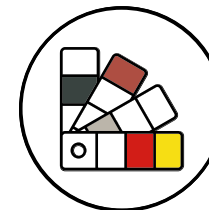

Personalización

Juntos definimos tus necesidades y tus expectativas. Y juntos diseñamos un producto especial para ti. No hay dos iguales.

Functionality

Design and functionality in perfect harmony. The versatility to adapt to emerging lifestyles and settings, whether simple or ostentatious.

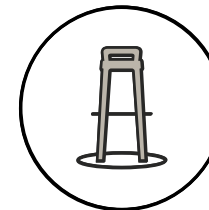

Funcionalidad

Diseño y funcionalidad en perfecto equilibrio. Versatilidad que se adapta a estilos de vida y espacios dispares, tan sencillos como extravagantes.

Sustainability and local production

There's no greater commitment to the planet than respectful manufacturing, so that our items can last a lifetime with you. That's our commitment: durability.

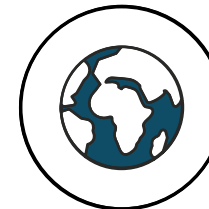

Sostenibilidad y producción local

No hay mayor compromiso con el planeta que fabricar piezas de forma respetuosa y que estén a nuestro lado toda una vida. Ese es el nuestro: la durabilidad.

Play

Play brings us closer. It allows us to be ourselves once we've hung up the uniform of our daily routine.

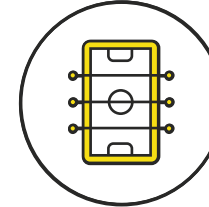

Juego

El juego nos acerca. Nos une. Nos permite ser nosotros mismos una vez hemos colgado en el armario nuestro uniforme para la rutina.

Sharing

There's no better feeling than sharing the good times with your loved ones. We aim to help you live those moments.

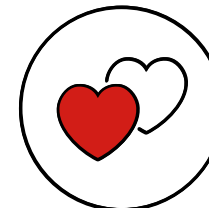

Compartir

No hay mejor sensación que la de compartir los buenos momentos con los tuyos. Nuestro deseo, ayudarte a vivirlos.

Design & designers

Working with designers means to be imbued by their artistic freedom and discovering new approaches to design and aesthetics, adding talent that brings experience and a fresh perspective to our universe.

Trabajar con diseñadores es empaparnos de su libertad artística y descubrir otras aproximaciones al diseño y la estética. Sumar talento que aporta experiencia y savia fresca a nuestro universo.



Antoni Pallejà Office



Emiliana Design Studio



Rafael Rodríguez



Stone Designs



José Andrés



Mermelada Estudio



Yonoh



This book is an interactive pdf.
 You can jump directly to any product by clicking on its name in the index. And you can return to the product index or to the main index from any page by clicking on the 'index' or 'product data sheet index' black buttons at the bottom of each page.

Este libro es un pdf interactivo.
 Puedes saltar a cualquier producto haciendo clic en el título del índice. Y puedes volver al índice de productos o al índice general desde todas las páginas haciendo clic en los botones negros 'índice de fichas técnicas' o 'índice' que encontrarás en la parte inferior de cada página.

rs-barcelona

Product Fact Sheet Index

Diagonal Indoor Pool Table • Billar de Interior	112
Diagonal Outdoor Pool Table • Billar de Exterior	113
Diagonal Indoor Top • Sobre Interior	114
Diagonal Outdoor Top • Sobre Exterior	115
Mou Indoor Floor Cue Rack • Carrito de Interior	116
Mou Outdoor Floor Cue Rack • Carrito de Exterior	117
You and Me Indoor Ping Pong Table • Ping-Pong Interior	118
You and Me Outdoor Ping Pong Table • Ping-Pong Exterior	119
You and Me Bench • Banco	120
RS Stationary Ping Pong Table • Ping-Pong	122
RS Folding Ping Pong Table • Ping-Pong	123
RS2 Football Table • Fútbolín	124
RS2 Gold Football Table • Fútbolín	125
RS2 Dining Football Table • Fútbolín Mesa	126
RS3 Wood Football Table • Fútbolín	127
RS3 Wood Gold Football Table • Fútbolín	128
RS3 Wood Dining Football Table • Fútbolín Mesa	129
RS3 Football Table • Fútbolín	130
RS4 Home Football Table • Fútbolín	131
RS Max Football Table • Fútbolín	132
RS Max Dining Football Table • Fútbolín Mesa	133
Plec Rectangular Occasional Table • Mesa de Centro Rectangular	134
Plec Round Occasional Table • Mesa de Centro Redonda	135
Plec Desk • Escritorio	136
Plec Pedestal • Pedestal	137
Be Around Table • Mesa	138
Ombra Stool • Taburete	142
On the Road Bench • Banco	144
Mon Oncle Barbecue • Barbacoa	145
Wall Champions 1 Coat Hock • Colgador	146
Wall Champions 4 Coat Rack • Colgador	146
Customisation • Customización	148
Design & colours • Diseño y colores	152
Design & quality • Diseño y calidad	154

rs-barcelona

Diagonal

Yonoh, 2018
Indoor Pool Table
Billar de Interior



Structure • Estructura



Cloth • Tapete



Legs • Patas

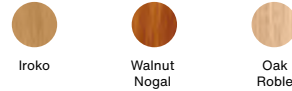

Materials

Structure: Steel with micro textured polyester paint.
Cloth: Simonis 860 90% worsted wool and 10% nylon.
Board: 0.79 in | 20 mm thickness 1 piece fibre cement.
Legs: Steel with polyester paint and iroko wood.
Cushion: K66 premium rubber cushion.

Includes

Balls set (16 Aramith Premium Balls).
2 Cues (Dufferin club cue Canadian Maple).
1 Triangle.
1 Chalk Set (12 units).
1 Table Brush.

Materiales

Estructura: Acero y pintura poliéster micro texturado.
Tapete: Simonis 860 90% pura lana y 10% nylon.
Tablero: 1 pieza de fibro cemento de 20 mm de espesor.
Patas: Acero pintura poliéster y madera de iroko.
Cojinetes: Goma K66 premium.

Incluye

Set de bolas (16 bolas Aramith Premium).
2 Tacos (Dufferin club de arce canadiense).
1 Triángulo.
1 Set de tizas (12 unidades).
1 Cepillo para el tapete.

7ft American • Americano 7pies

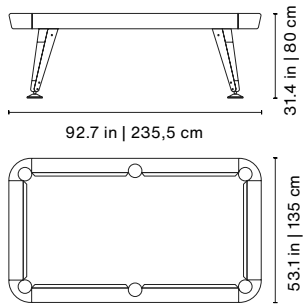

Playing area • Área de juego 78.7x39.4 in | 200x100 cm

Product weight • Peso del producto 439.8 lb | 224 kg

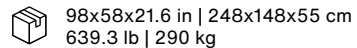

8ft American • Americano 8pies

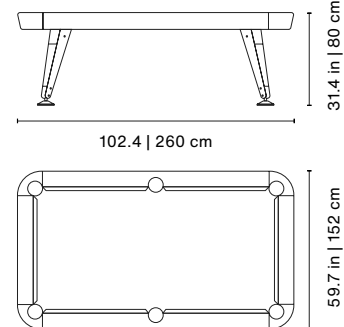

Playing area • Área de juego 88.2x44.1 in | 224x112 cm

Product weight • Peso del producto 529 lb | 240 kg

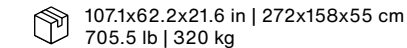

rs-barcelona

Diagonal

Yonoh, 2020
Outdoor Covered Pool Table
Billar de Exterior Cubierto



Structure • Estructura

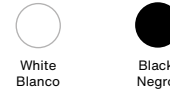

Cloth • Tapete



Legs • Patas



Materials

Structure: Primer coated steel with micro textured powder coated polyester paint.
Cloth: Sunbrella (100% acrylic).
Board: 0.79 in | 20 mm thickness 1 piece fibre cement.
Legs: Iroko wood.
Cushion: K66 premium rubber cushion.

Includes

Protective cover.
Balls set (16 Aramith Premium Balls).
2 Cues (Dufferin club cue Canadian Maple).
1 Triangle.
1 Chalk Set (12 units).
1 Table Brush.

Materiales

Estructura: Acero con imprimación y pintura poliéster en acabado micro texturado.
Tapete: Sunbrella (100% acrílico).
Tablero: 1 pieza de fibro cemento de 20 mm de espesor.
Patas: Madera de iroko.
Cojinetes: Goma K66 premium.

Incluye

Funda de protección.
Set de bolas (16 bolas Aramith Premium).
2 Tacos (Dufferin club de arce canadiense).
1 Triángulo.
1 Set de tizas (12 unidades).
1 Cepillo para el tapete.

7ft American • Americano 7pies

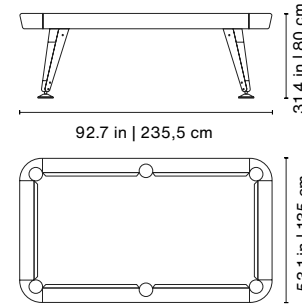

Playing area • Área de juego 78.7x39.4 in | 200x100 cm

Product weight • Peso del producto 439.8 lb | 224 kg

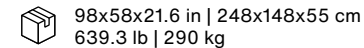

8ft American • Americano 8pies

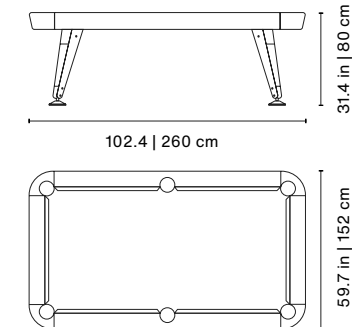

Playing area • Área de juego 88.2x44.1 in | 224x112 cm

Product weight • Peso del producto 529 lb | 240 kg

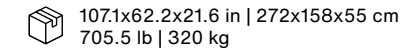

rs-barcelona

Diagonal

Yonoh, 2019
Indoor Top
Sobre Mesa de Interior



Finishes • Acabados



Iroko



Walnut
Nogal



Oak
Roble

Materials

Cross-ply and iroko, walnut or oak veneer.

It comes in three pieces.

7ft American • Americano 7pies

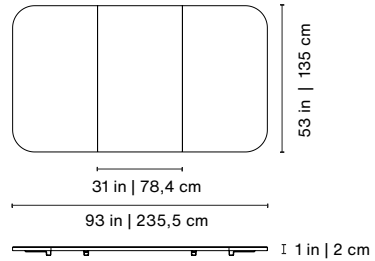

Product weight • Peso del producto 105.8 lb | 48 kg

57.8x35x9.8 in | 147x89x25 cm
114.6 lb | 55 kg

Materiales

Contrachapado en acabado iroko, nogal o roble.

Viene en tres piezas.

8ft American • Americano 8pies

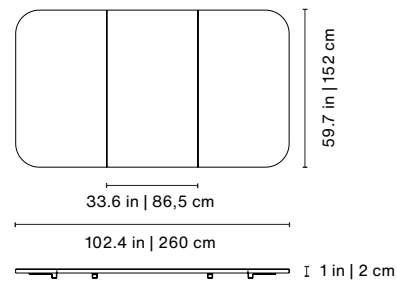

Product weight • Peso del producto 132.3 lb | 60 kg

63.4x37.4x10.2 in | 161x95x26 cm
147.7 lb | 67 kg

rs-barcelona

Diagonal

Yonoh, 2020
Outdoor Top
Sobre Mesa de Exterior



Finishes • Acabados



White
Blanco



Black
Negro

Materials

HPL (white or black).

It comes in three pieces.

7ft American • Americano 7pies

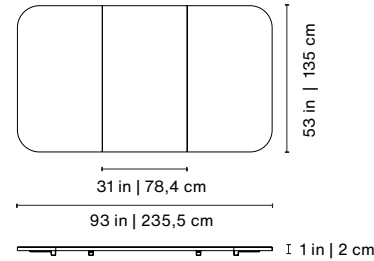

Product weight • Peso del producto 105.8 lb | 48 kg

57.8x35x9.8 in | 147x89x25 cm
114.6 lb | 55 kg

Materiales

HPL (blanco o negro)

Viene en tres piezas.

8ft American • Americano 8pies

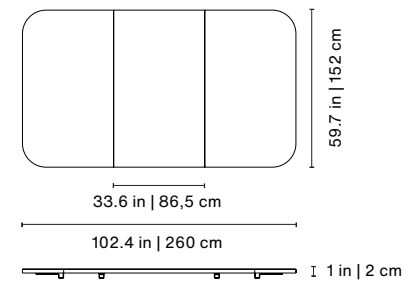

Product weight • Peso del producto 132.3 lb | 60 kg

63.4x37.4x10.2 in | 161x95x26 cm
147.7 lb | 67 kg

Mou

Yonoh, 2019
Indoor Floor Cue Rack
Carrito de Interior



rs-barcelona



Structure • Estructura



White
Blanco



Black
Negro



Red
Rojo



Blue
Azul



Green
Verde

Trays • Bandejas



Iroko



Walnut
Nogal



Oak
Roble

Materials

Structure: Steel with micro textured polyester paint.
Trays: Croosply and iroko, walnut or oak veneer.

Includes

Wheels.

The Mou floor cue rack does not include the Diagonal accessories. They come with the pool table.

Materiales

Estructura: Acabado de acero y pintura poliéster micro texturada.
Bandejas: Contrachapado acabado en iroko, nogal o roble.

Incluye

Ruedas.

El carrito no incluye los accesorios del Diagonal. Estos vienen con la mesa de billar.

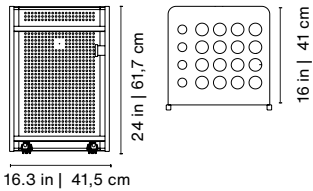

Product weight • Peso del producto 33 lb | 15 kg

18.9x17.3x26.4 in | 48x44x67 cm
35.5 lb | 16 kg

rs-barcelona



Structure • Estructura



White
Blanco



Black
Negro

Materials

Structure: Primer coated steel with micro textured powder coated polyester paint.
Trays: HPL (white or black).
Wooden details: Iroko wood.

Includes

Wheels.
Protective cover.

The Mou floor cue rack does not include the Diagonal accessories. They come with the pool table.

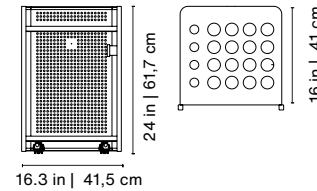

Product weight • Peso del producto 33 lb | 15 kg

18.9x17.3x26.4 in | 48x44x67 cm
35.5 lb | 16 kg

Mou

Yonoh, 2020
Outdoor Floor Cue Rack
Carrito de Exterior



Materiales

Estructura: Acero con imprimación y pintura poliéster en acabado micro texturado.
Bandejas: HPL (blanco o negro).
Detalles madera: Iroko.

Incluye

Ruedas.
Funda de protección.

El carrito no incluye los accesorios del Diagonal. Estos vienen con la mesa de billar.

rs-barcelona

You and Me

Antoni Pallejà Office, 2013
Indoor Ping Pong Table
Ping-Pong Interior



Structure • Estructura



White
Blanco



Black
Negro

Top and Legs • Sobre y Patas



Iroko



Walnut
Nogal



Oak
Roble

Materials

Structure: Steel with cathaphoretic coating process and micro textured powder coated polyester paint.
Top: Walnut or oak wood.
Legs: Walnut or oak wood.
Net: Coated polyester fabric.

Materiales

Estructura: Acero con cataforesis y pintura poliéster con acabado micro texturado.
Sobre: Madera de nogal o roble.
Patas: Madera de nogal o roble.
Red: Poliéster.

Includes

Net.
Paddles set (2 units).
Balls set (6 units).

Incluye

Red.
Set de palas (2 unidades).
Set de bolas (6 unidades).

Standard

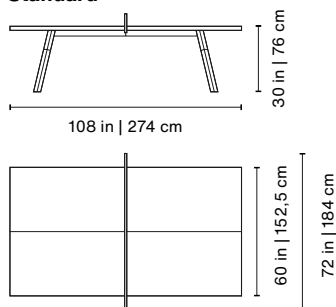

220 Medium - 220 Mediana

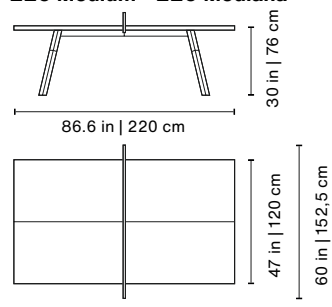

180 Small - 180 Pequeña

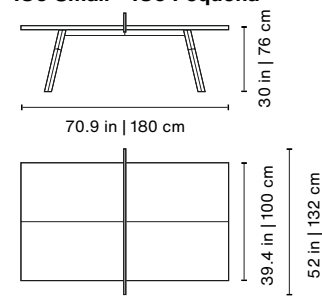

Product weight • Peso del producto
260 lb | 118 kg

64.6x59.8x20.7 in |
164x152x53 cm
330.7 lb | 150 kg

Product weight • Peso del producto
220.5 lb | 100 kg

88.6x52.6x19.7 in |
225x134,2x50 cm
265 lb | 120 kg

Product weight • Peso del producto
165.3 lb | 75 kg

74.8x46x20.8 in |
190x117x53 cm
220.5 lb | 100 kg

You and Me
Collection

rs-barcelona

You and Me

Antoni Pallejà Office, 2013
Outdoor Ping Pong Table
Ping-Pong Exterior



Structure and Top • Estructura y Sobre



White
Blanco



Black
Negro

Legs • Patas



Iroko

Materials

Structure: Steel with cathaphoretic coating process and micro textured powder coated polyester paint.
Top: HPL (white or black).
Legs: Iroko wood.
Net: Coated polyester fabric.

Materiales

Estructura: Acero con cataforesis y pintura poliéster en acabado micro texturado.
Sobre: HPL (blanco o negro).
Patas: Madera de iroko.
Red: Poliéster.

Includes

Net.
Paddles set (2 units).
Balls set (6 units).

Incluye

Red.
Set de palas (2 unidades).
Set de bolas (6 unidades).

Standard

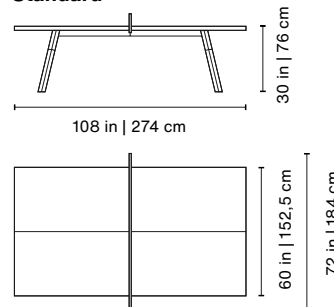

220 Medium - 220 Mediana

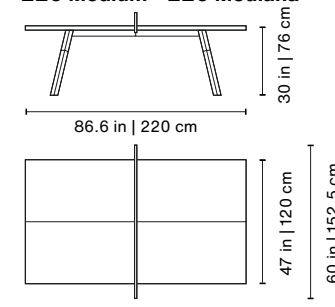

180 Small - 180 Pequeña

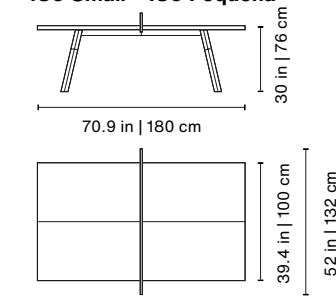

Product weight • Peso del producto
238 lb | 108 kg

64.6x59.8x20.7 in |
164x152x53 cm
308.5 lb | 140 kg

Product weight • Peso del producto
165 lb | 75 kg

88.6x52.6x19.7 in |
225x134,2x50 cm
220.5 lb | 100 kg

Product weight • Peso del producto
143.3 lb | 65 kg

74.8x46x20.8 in |
190x117x53 cm
165 lb | 75 kg

You and Me
Collection

rs-barcelona

You and Me

Antoni Pallejà Office, 2015
Bench
Banco



Structure • Estructura



White
Blanco



Black
Negro

Materials

Structure: Steel with cataphoretic coating process and micro textured powder coated polyester paint.

Seat: Iroko or oak wood (oak finish only for indoor use).

Product options

Ask for custom sizes.

285 Bench • Banco 285

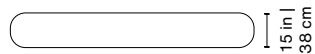
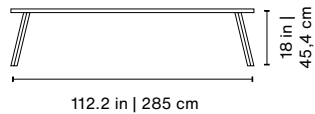

Product weight • Peso del producto 83.7 lb | 38 kg

116x19x6 in | 295x48,3x15,2 cm
88.2 lb | 40 kg

180 Bench • Banco 180

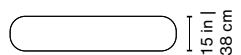
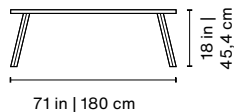

Product weight • Peso del producto 55 lb | 25 kg

75x19x6 in | 190,5x48,3x15,2 cm
60 lb | 27,2 kg

Seat • Asiento



Iroko



Oak
Roble

Materiales

Estructura: Acero con cataforesis y pintura poliéster en acabado micro texturado.

Asiento: Madera de iroko o roble (acabado roble solo para uso interior).

Opciones

Pregúntanos por otras medidas.

220 Bench • Banco 220

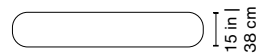
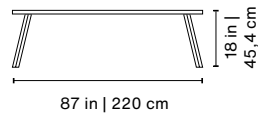

Product weight • Peso del producto 70 lb | 31,4 kg

90x19x6 in | 231,1x48,3x15,2 cm
72 lb | 32,6 kg

160 Bench • Banco 160

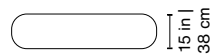
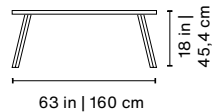

Product weight • Peso del producto 49 lb | 22,2 kg

70.9x19x6 in | 180x48,3x15,2 cm
57 lb | 26 kg

120 Bench • Banco 120

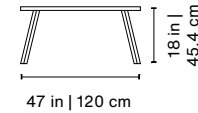

Product weight • Peso del producto 38 lb | 17 kg

52x19x6 in | 132,1x48,3x15,2 cm
42 lb | 19 kg

Stool • Taburete 50

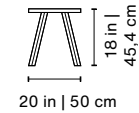

Product weight • Peso del producto 17.8 lb | 8 kg

24x19x6 in | 61x48,3x15,2 cm
20 lb | 9,1 kg



Cushions • Cojines



Finishes • Acabados



White
Blanco



Dark Taupe

Materials

Upholstery: Natté from Sunbrella (100% acrylic).

Materiales

Tapizado: Natté de Sunbrella (100% acrílico).

285

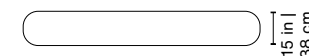
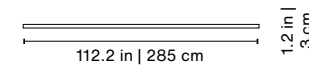

Product weight • Peso del producto 5.8 lb | 2,6 kg

160

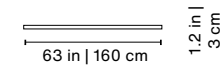

Product weight • Peso del producto 3.1 lb | 1,4 kg

220

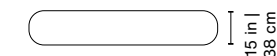
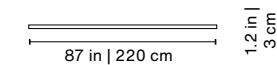

Product weight • Peso del producto 4.4 lb | 2 kg

120

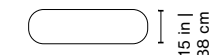
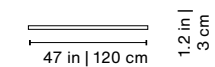

Product weight • Peso del producto 2.4 lb | 1 kg

180

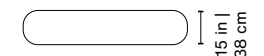
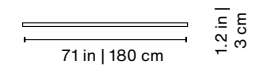

Product weight • Peso del producto 3.6 lb | 1,6 kg

50

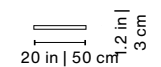

Product weight • Peso del producto 1 lb | 0,45 kg

You and Me
Collection

rs-barcelona

RS Stationary

Rafael Rodríguez, 2017
Ping Pong Table
Ping-Pong



Structure and Top • Estructura y Sobre



White
Blanco



Black
Negro

Materials

Structure: Steel with cathaporetic coating process and micro textured powder coated polyester paint.

Top: HPL (white or black).

Legs: Iroko wood.

Net: Coated polyester fabric.

Includes

Net.

Paddles set (2 units).

Balls set (6 units).

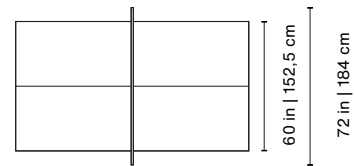
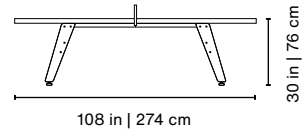

Product weight • Peso del producto 264.5 lb | 120 kg



68x70x21 in | 172,7x154,9x53,3 cm
330.7 lb | 150 kg

rs-barcelona

RS Folding

Rafael Rodríguez, 2017
Ping Pong Table
Ping-Pong



Structure and Top • Estructura y Sobre



White
Blanco



Black
Negro

Materials

Structure: Steel with cathaporetic coating process and micro textured powder coated polyester paint.

Top: HPL (white or black).

Legs: Iroko wood.

Net: Coated polyester fabric.

Includes

Net.

Paddles set (2 units).

Balls set (6 units).

It comes assembled.

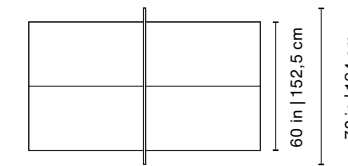
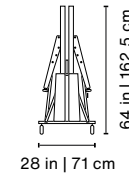
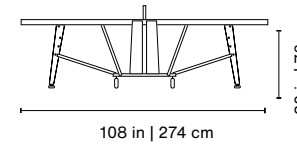

Product weight • Peso del producto 286.6 lb | 130 kg



68x32x73 in | 172,7x81,3x185,4 cm
330.7 lb | 150 kg

rs-barcelona

RS2

Rafael Rodríguez, 2006
Football Table
Futbolín



Indoor • Interior

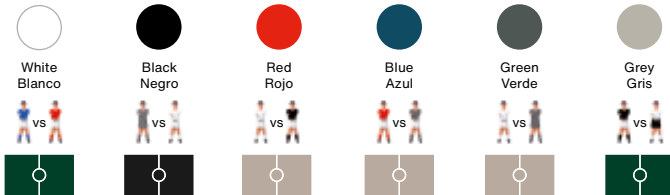

Outdoor • Exterior

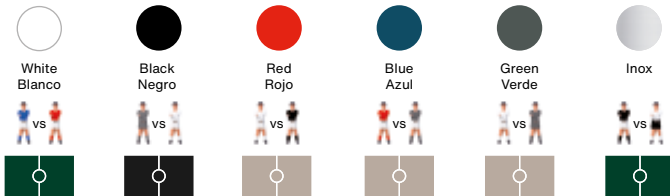

Materials

Outdoor Inox finish: Shot blasted stainless steel lacquered.
Outdoor RAL colour finish: Stainless steel and micro textured powder coated polyester paint.
Indoor RAL colour finish: Steel and micro textured powder coated polyester paint.
Field: HPL (green, cream or black).
Players: Cast aluminium.

Includes

Balls set (7 units).
2 extra players (1 per team).

Materiales

Acabado Inox: Acero inoxidable granallado y lacado.
Acabado color RAL exterior: Acero inoxidable y pintura poliéster con acabado micro texturado.
Acabado color RAL interior: Acero y pintura poliéster con acabado micro texturado.
Campo: HPL (verde, crema o negro).
Jugadores: Aluminio fundido.

Incluye

Set de bolas (7 unidades).
2 jugadores extra (1 por equipo).

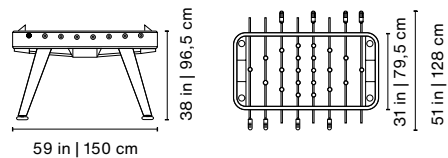

Product weight • Peso del producto 196.2 lb | 89 kg

63x53x22 in | 160x134,6x55,9 cm
266.8 lb | 121 kg

rs-barcelona

RS2 Gold

Rafael Rodríguez, 2016
Football Table
Futbolín



Colours • Colores

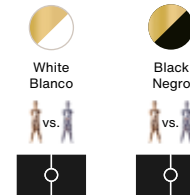

Materials

Structure: Stainless steel and micro textured powder coated polyester paint.
Field: HPL (black).
Players: Cast aluminium in gold and silver chrome plating.
Handles: Wood with polyester paint.
Gold chrome plating bearing: The score counter, ball bearing, screws and other small pieces.

Includes

Balls set (7 units).
2 extra players (1 per team).

Materiales

Estructura: Acero inoxidable y pintura poliéster con acabado micro texturado.
Campo: HPL (negro).
Jugadores: Aluminio fundido cromado en oro y plata.
Mangos: Madera y pintura poliéster.
Piezas cromadas en baño de oro: Los cuentagoles, cojinetes, tornillos y algunas pequeñas piezas.

Incluye

Set de bolas (7 unidades).
2 jugadores extra (1 por equipo).

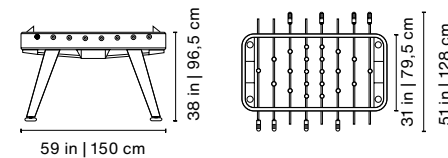

Product weight • Peso del producto 196.2 lb | 89 kg

63x53x22 in | 160x134,6x55,9 cm
266.8 lb | 121 kg

rs-barcelona

RS2 Dining

José Andrés & Rafael Rodríguez, 2014
Football Dining Table
Futbolín Mesa



Indoor • Interior

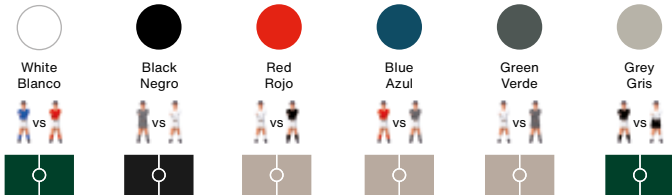

Outdoor • Exterior

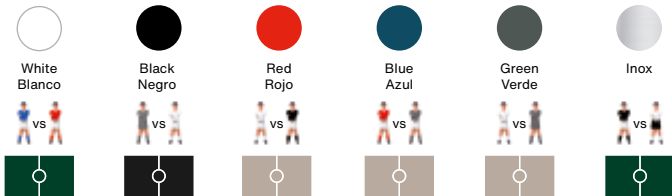

Materials

Outdoor Inox finish: Shot blasted stainless steel lacquered.
Outdoor RAL colour finish: Stainless steel and micro textured powder coated polyester paint.
Indoor RAL colour finish: Steel and micro textured powder coated polyester paint.
Glass: 0.4 in | 1 cm tempered glass.
Field: HPL (green, cream or black).
Players: Cast aluminium.
Handles: Iroko wood.

Includes

Balls set (7 units).
2 extra players (1 per team).

Materiales

Acabado Inox: Acero inoxidable granallado y lacado.
Acabado color RAL exterior: Acero inoxidable y pintura poliéster con acabado micro texturado.
Acabado color RAL interior: Acero y pintura poliéster con acabado micro texturado.
Cristal: Vidrio templado de 1 cm de espesor.
Campo: HPL (verde, crema o negro).
Jugadores: Aluminio fundido.
Mangos: Madera de iroko.

Incluye

Set de bolas (7 unidades).
2 jugadores extra (1 por equipo).

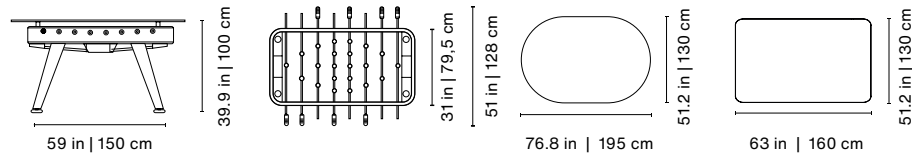

Product weight • Peso del producto 324 lb | 147 kg

80.3x59x33.3 in | 204x152x77 cm
557.8 lb | 253 kg

rs-barcelona

RS3 Wood

Rafael Rodríguez, 2012
Football Table
Futbolín



Colours • Colores

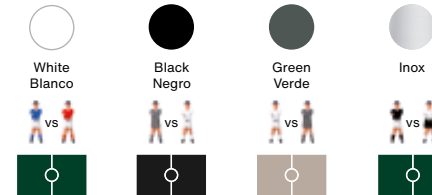

Materials

Inox finish: Shot blasted stainless steel lacquered.
RAL colour finish: Steel with cataphoretic coating process and micro textured powder coated polyester paint.
Field: HPL (green, cream or black).
Players: Cast aluminium.
Handles: Iroko wood.
Legs: Iroko wood.

Includes

Balls set (7 units).
2 extra players (1 per team).

Materiales

Acabado Inox: Acero inoxidable granallado y lacado.
Acabado color RAL: Acero con cataforesis y pintura poliéster con acabado micro texturado.
Patas: Madera de iroko.
Campo: HPL (verde, crema o negro).
Jugadores: Aluminio fundido.
Mangos: Madera de iroko.

Incluye

Set de bolas (7 unidades).
2 jugadores extra (1 por equipo).

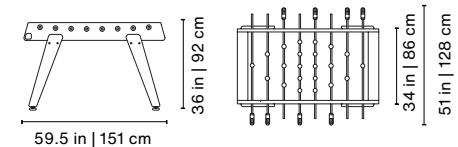

Product weight • Peso del producto 172 lb | 78 kg

63x53x22 in | 160x134,6x55,9 cm
242.5 lb | 110 kg

rs-barcelona

RS3 Wood Gold

Rafael Rodríguez, 2016
Football Table
Futbolín



Colours • Colores



Black
Negro



Materials

Structure: Steel with cathophoretic coating process and micro textured powder coated polyester paint.
Legs: Black stained iroko wood.
Field: HPL (black).
Players: Cast aluminium in gold and silver chrome plating.
Handles: Black stained iroko wood.
Gold chrome plating bearing: The score counter, ball bearing, screws and other small pieces.

Includes

Balls set (7 units).
2 extra players (1 per team).

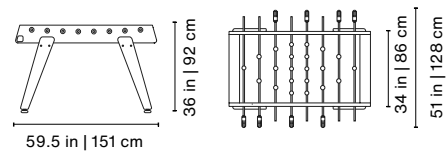

Product weight • Peso del producto 172 lb | 78 kg

63x53x22 in | 160x134,6x55,9 cm
242.5 lb | 110 kg

Materiales

Estructura: Acero inoxidable y pintura poliéster con acabado micro texturado.
Patas: Madera de iroko teñida de negro.
Campo: HPL (negro).
Jugadores: Aluminio fundido cromado en oro y plata.
Mangos: Madera de iroko teñida de negro.
Piezas cromadas en baño de oro: Los cuentagoles, cojinetes, tornillos y algunas pequeñas piezas.

Incluye

Set de bolas (7 unidades).
2 jugadores extra (1 por equipo).

rs-barcelona

RS3 Wood Dining

Rafael Rodríguez, 2020
Football Dining Table
Futbolín Mesa



Colours • Colores



White
Blanco



Black
Negro



Green
Verde



Inox



Materials

Inox finish: Shot blasted stainless steel lacquered.
RAL colour finish: Steel with cathophoretic coating process and micro textured powder coated polyester paint.
Glass: 0.4 in | 1 cm tempered glass.
Field: HPL (green, cream or black).
Players: Cast aluminium.
Handles: Iroko wood.
Legs: Iroko wood.

Includes

Balls set (7 units).
2 extra players (1 per team).

Materiales

Acabado Inox: Acero inoxidable granallado y lacado.
Acabado color RAL exterior: Acero inoxidable y pintura poliéster con acabado micro texturado.
Cristal: Vidrio templado de 1 cm de espesor.
Campo: HPL (verde, crema o negro).
Jugadores: Aluminio fundido.
Mangos: Madera de iroko.
Patas: Madera de iroko.

Incluye

Set de bolas (7 unidades).
2 jugadores extra (1 por equipo).

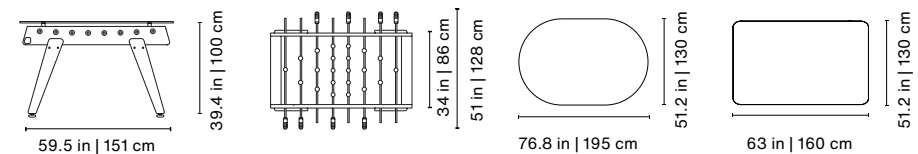

Product weight • Peso del producto 295.4 lb | 134 kg

80.3x59x33.3 in | 204x152x77 cm
530.2 lb | 240,5 kg

rs-barcelona

RS3

Rafael Rodríguez, 2011
Football Table
Futbolín



Colours • Colores



White
Blanco



Black
Negro



Red
Rojo



Green
Verde



Materials

Structure: Steel with cathoretic coating process and micro textured powder coated polyester paint.

Field: HPL (green, cream or black).

Players: Cast aluminium.

Handles: Wood with polyester paint.

Includes

Balls set (7 units).

2 extra players (1 per team).

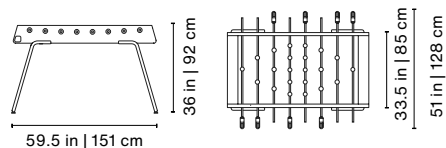

Product weight • Peso del producto 145.5 lb | 66 kg

63x53x22 in | 160x134,6x55,9 cm
216 lb | 98 kg

Materiales

Estructura: Acero con cataforesis y pintura poliéster con acabado micro texturado.

Campo: HPL (verde, crema o negro).

Jugadores: Aluminio fundido.

Mangos: Madera y pintura poliéster.

Incluye

Set de bolas (7 unidades).

2 jugadores extra (1 por equipo).

rs-barcelona



RS4 Home

Rafael Rodríguez, 2020
Football Table
Futbolín



Colours • Colores



Grey
Gris



Yellow
Amarillo



Terracotta
Terracota



Blue
Azul



Materials

Structure: Steel with cathoretic coating process and micro textured powder coated polyester paint.

Field: HPL (grey).

Players: Cast aluminium.

Handles: Iroko wood.

Legs: Iroko wood

Includes

Balls set (7 units).

2 extra players (1 per team).

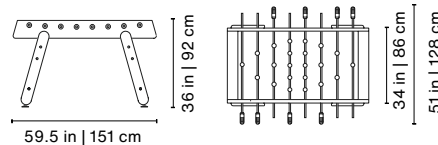

Product weight • Peso del producto 136.7 lb | 62 kg

63x35.4x15 in | 160x90x38 cm
202.8 lb | 92 kg

Materiales

Estructura: Acero con cataforesis y pintura poliéster en acabado micro texturado.

Campo: HPL (gris).

Patas: Madera de iroko.

Jugadores: Aluminio fundido.

Mangos: Madera de iroko.

Incluye

Set de bolas (7 unidades).

2 jugadores extra (1 por equipo).



Easy assembling, for doing it yourself with no need of a professional team.

rs-barcelona

RS Max

Rafael Rodríguez, 2020
Football Table
Futbolín



Colours • Colores

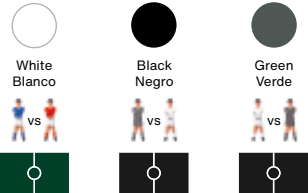

Materials

Structure: Steel with cathaphoretic coating process and micro textured powder coated polyester paint.
Field: HPL (green or black).
Players: Cast aluminium.
Handles: Iroko wood.
Legs: Iroko wood.

Includes

Balls set (7 units).
4 extra players (2 per team).

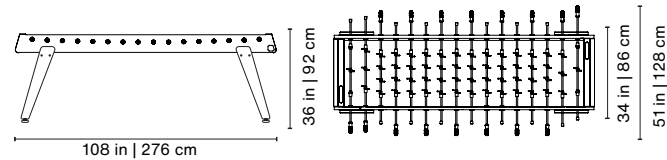

Product weight • Peso del producto 275.6 lb | 125 kg

113.4x52x20.9 in | 288x132x53 cm
445.3 lb | 202 kg

Materiales

Estructura: Acero con cataforesis y pintura poliéster con acabado micro texturado.
Campo: HPL (verde o negro).
Jugadores: Aluminio fundido.
Mangos: Madera y pintura poliéster.
Patas: Madera de iroko.

Incluye

Set de bolas (7 unidades).
4 jugadores extra (2 por equipo).

rs-barcelona

RS Max Dining

Rafael Rodríguez, 2020
Football Dining Table
Futbolín Mesa

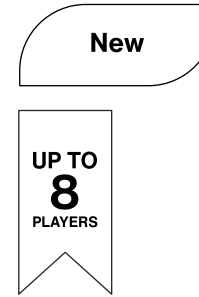

Colours • Colores

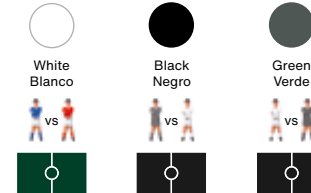

Materials

Structure: Steel with cathaphoretic coating process and micro textured powder coated polyester paint.
Glass: 0.4 in | 1 cm templated glass.
Field: HPL (green or black).
Players: Cast aluminium.
Handles: Iroko wood.
Legs: Iroko wood.

Includes

Balls set (7 units).
4 extra players (2 per team).

Materiales

Estructura: Acero con cataforesis y pintura poliéster con acabado micro texturado.
Cristal: Vidrio templado de 1 cm de espesor.
Campo: HPL (verde o negro).
Jugadores: Aluminio fundido.
Mangos: Madera de iroko.
Patas: Madera de iroko.

Incluye

Set de bolas (7 unidades).
4 jugadores extra (2 por equipo).

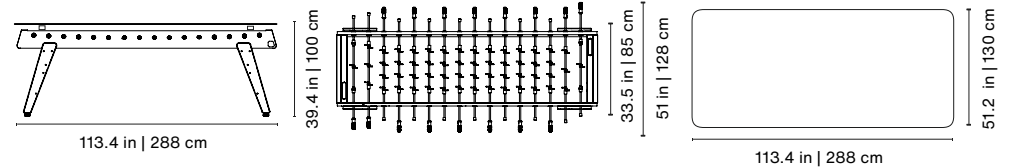

Product weight • Peso del producto 619.5 lb | 281 kg

116.1x55.1x30.1 in | 295x140x77 cm
813.5 lb | 369 kg

rs-barcelona

Plec

Antoni Pallejà Office, 2017
Rectangular Occasional Table
Mesa de Centro Rectangular



Plec
Collection

Steel • Acero



White
Blanco



Black
Negro



Terracotta
Terracota



Green
Verde

Marble • Mármol



White Carrara



Black Marquina



Red Francia



Green Aver

Materials

Steel with cathaphoretic coating process and micro textured powder coated polyester paint.
Top: Steel or marble.

All the table sizes include levelers.

Product options

Steel legs and top or steel legs and marble top.

Materiales

Acero con cataforesis y pintura poliéster en acabado micro texturado.
Sobre: Acero o mármol.

Todas las medidas incluyen nivelador.

Opciones

Patas y sobre de acero o patas de acero y sobre de mármol.

Large • Grande

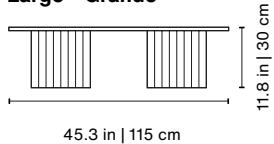

45.3 in | 115 cm

11.8 in | 30 cm



23.5 in | 60 cm

Medium • Mediana

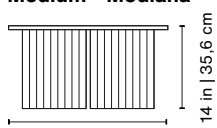

27.5 | 70 cm

14 in | 35.6 cm

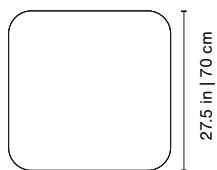

27.5 in | 70 cm

Small • Pequeña

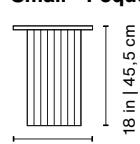

14.8 in | 37.5 cm

18 in | 45.5 cm

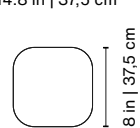

14.8 in | 37.5 cm

Steel • Acero

Product weight • Peso del producto
52.5 lb | 23,8 kg



47.2x26x19.7 in |
120x66x50 cm
55.12 lb | 25 kg

Steel • Acero

Product weight • Peso del producto
45.2 lb | 20,5 kg



29.5x29.5x15.4 in |
75x75x39 cm
48,5 lb | 22 kg

Steel • Acero

Product weight • Peso del producto
18.3 lb | 8,3 kg



16.5x16.5x20.1 in |
42x42x51 cm
22 lb | 10 kg

Marble • Mármol

Product weight • Peso del producto
92.6 lb | 42 kg



49.2x27.6x19.7 in |
125x70x50 cm
152.1 lb | 69 kg

Marble • Mármol

Product weight • Peso del producto
75 lb | 34 kg



31.5x31.5x22.4 in |
80x80x57 cm
120.2 lb | 54,5 kg

Marble • Mármol

Product weight • Peso del producto
25.6 lb | 11,6 kg



17.7x17.7x19.7 in |
45x45x50 cm
35.3 lb | 16 kg

rs-barcelona

Plec

Antoni Pallejà Office, 2017
Round Occasional Table
Mesa de Centro Redonda



New

Plec
Collection

Steel • Acero



White
Blanco



Black
Negro



Terracotta
Terracota



Green
Verde

Marble • Mármol



White Carrara



Black Marquina



Red Francia



Green Aver

Materials

Steel with cathaphoretic coating process and micro textured powder coated polyester pain.
Top: Steel or marble.

All the table sizes include levelers.

Product options

Steel legs and top or steel legs and marble top.

Materiales

Acero con cataforesis y pintura poliéster en acabado micro texturado.
Sobre: Acero o mármol.

Todas las medidas incluyen nivelador.

Opciones

Patas y sobre de acero o patas de acero y sobre de mármol.

Large • Grande



35.5 in | 90 cm

12.6 in | 32 cm

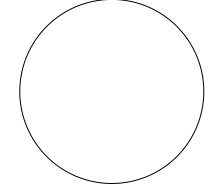

35.5 in | 90 cm

Small • Pequeña

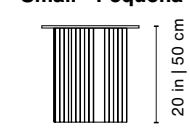

20 in | 50 cm

20 in | 50 cm

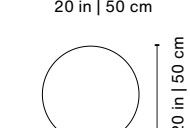

20 in | 50 cm

Steel • Acero

Product weight • Peso del producto
44 lb | 29 kg



37.4x37.4x18.5 in |
95x95x47 cm
81.6 lb | 37 kg

Steel • Acero

Product weight • Peso del producto
30.9 lb | 14 kg



21.7x21.7x21.7 in |
55x55x55 cm
33 lb | 15 kg

Marble • Mármol

Product weight • Peso del producto
114.6 lb | 52 kg



39.8x39.8x21.8 in |
101x101x55.5 cm
163.1 lb | 74 kg

Marble • Mármol

Product weight • Peso del producto
48.5 lb | 22 kg



26x24x22 in |
66x61x56 cm
61.7 lb | 28 kg

Plec

Antoni Pallejà Office, 2020
Desk
Escritorio



rs-barcelona



Steel • Acero



White
Blanco



Black
Negro



Terracotta
Terracota



Green
Verde

Marble • Mármol



White Carrara



Black Marquina



Red Francia



Green Aver

Materials

Steel with cataphoretic coating process and micro textured powder coated polyester paint.
Top: Steel or marble.

Include levelers.

Product options

Steel legs and top or steel legs and marble top.

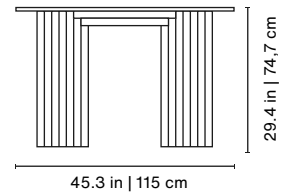

Steel • Acero

Product weight • Peso del producto
90.4 lb | 41 kg

47.2x26x36.6 in |
120x66x93 cm
108 lb | 49 kg

Marble • Mármol

Product weight • Peso del producto
134.5 lb | 61 kg

49.2x27.5x38 in |
125x70x96,5 cm
185.2 lb | 84 kg

Plec
Collection

rs-barcelona



Steel • Acero



White
Blanco



Black
Negro



Terracotta
Terracota



Green
Verde

Materials

Steel with cataphoretic coating process and micro textured powder coated polyester paint.
Top: Steel.

Include levelers.

Materiales

Acero con cataforesis y pintura poliéster en acabado micro texturado.
Sobre: Acero.

Incluye nivelador.

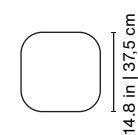
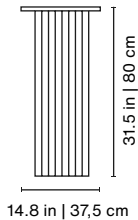

Product weight • Peso del producto
29.8 lb | 13,5 kg

16.5x16.5x33.8 in |
42x42x86 cm
32 lb | 14,5 kg

Plec
Collection

Plec

Antoni Pallejà Office, 2017
Pedestal



Be Around

rs-barcelona

Antoni Pallejà Office, 2015
Table
Mesa



Structure • Estructura



White
Blanco



Black
Negro

Top • Sobre



Iroko

Materials

Structure: Steel with cataphoretic coating process and micro textured powder coated polyester paint.
Top: Iroko wood

Materiales

Estructura: Acero con cataforesis y pintura poliéster en acabado micro texturado.
Sobre: Madera de iroko.

Product options

Ask for power socket options.

Opciones

Pregúntanos por las opciones de electrificación.

180

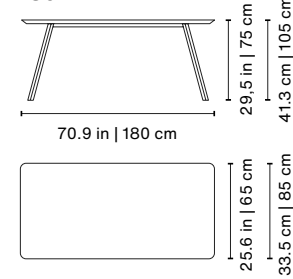

Low 65 W rs-barcelona

Product weight • Peso del producto
79.4 lb | 36 kg

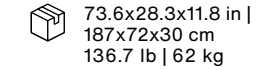

Low 85 W

Product weight • Peso del producto
92.6 lb | 42 kg

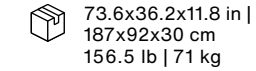

Tall 65 W

Product weight • Peso del producto
79.4 lb | 36 kg

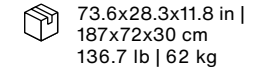

Tall 85 W

Product weight • Peso del producto
92.6 lb | 42 kg

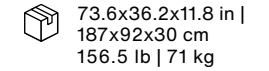

160

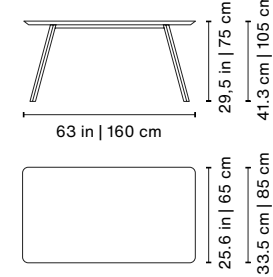

Low 65 W

Product weight • Peso del producto
70.5 lb | 32 kg

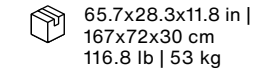

Low 85 W

Product weight • Peso del producto
81.6 lb | 37 kg

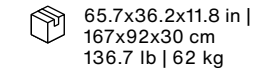

Tall 65 W

Product weight • Peso del producto
70.5 lb | 32 kg

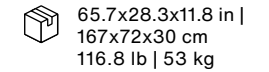

Tall 85 W

Product weight • Peso del producto
81.6 lb | 37 kg

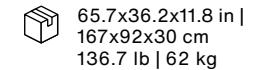

285

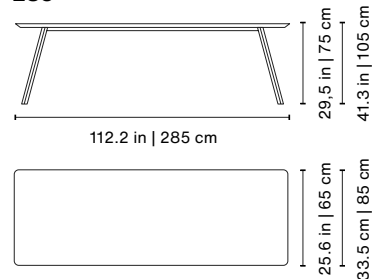

Low 65 W

Product weight • Peso del producto
125.7 lb | 57 kg

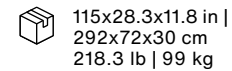

Low 85 W

Product weight • Peso del producto
138.9 lb | 63 kg

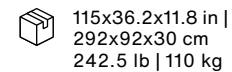

Tall 65 W

Product weight • Peso del producto
125.7 lb | 57 kg

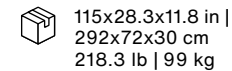

Tall 85 W

Product weight • Peso del producto
138.9 lb | 63 kg

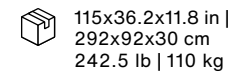

120

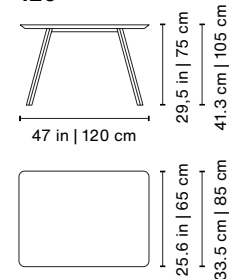

Low 65 W

Product weight • Peso del producto
52.9 lb | 24 kg

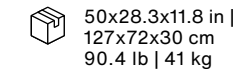

Low 85 W

Product weight • Peso del producto
61.7 lb | 28 kg

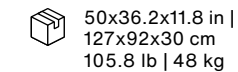

Tall 65 W

Product weight • Peso del producto
52.9 lb | 24 kg

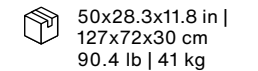

Tall 85 W

Product weight • Peso del producto
61.7 lb | 28 kg

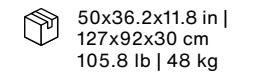

220

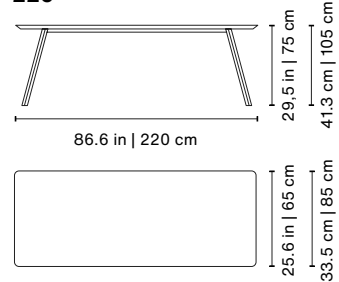

Low 65 W

Product weight • Peso del producto
97 lb | 44 kg

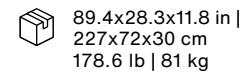

Low 85 W

Product weight • Peso del producto
114.6 lb | 52 kg

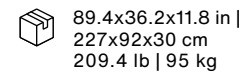

Tall 65 W

Product weight • Peso del producto
97 lb | 44 kg

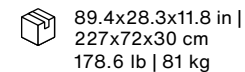

Tall 85 W

Product weight • Peso del producto
114.6 lb | 52 kg

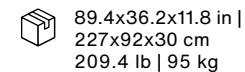

120 Square • 120 Cuadrada

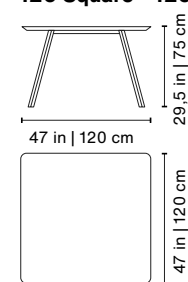

Product weight • Peso del producto
105.8 lb | 48 kg

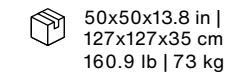

100 Square • 100 Cuadrada

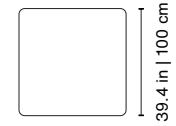
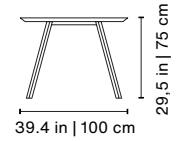

rs-barcelona

Product weight • Peso del producto
92.6 lb | 42 kg

 42.1x42.1x13.8 in |
107x107x35 cm
138.9 lb | 63 kg

100 Round • 100 Redonda

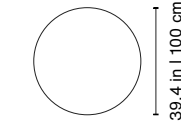
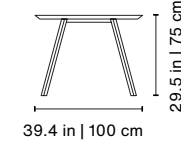

rs-barcelona

Product weight • Peso del producto
90.4 lb | 41 kg

 42.1x42.1x13.8 in |
107x107x35 cm
136.7 lb | 62 kg

85 Square • 85 Cuadrada

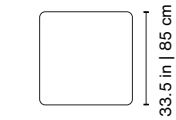
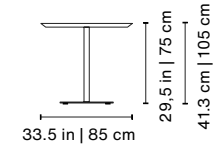

Low

Product weight • Peso del producto
75 lb | 34 kg

 36.2x36.2x13.8 in |
92x92x35 cm
108 lb | 49 kg

Tall

Product weight • Peso del producto
77.2 lb | 35 kg

 36.2x36.2x13.8 in |
92x92x35 cm
110.2 lb | 50 kg

85 Round • 85 Redonda

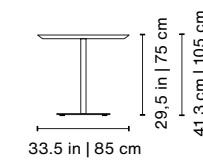

Low

Product weight • Peso del producto
72.8 lb | 33 kg

 36.2x36.2x13.8 in |
92x92x35 cm
105.8 lb | 48 kg

Tall

Product weight • Peso del producto
75 lb | 34 kg

 36.2x36.2x13.8 in |
92x92x35 cm
108 lb | 49 kg

65 Square • 65 Cuadrada

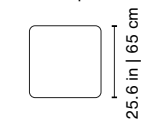
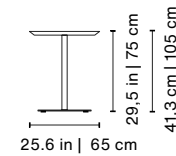

Low

Product weight • Peso del producto
61.7 lb | 28 kg

 28.3x28.3x13.8 in |
72x72x35 cm
83.8 lb | 38 kg

Tall

Product weight • Peso del producto
63.9 lb | 29 kg

 28.3x28.3x13.8 in |
72x72x35 cm
86 lb | 39 kg

65 Round • 65 Redonda

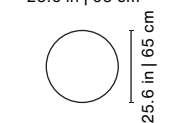
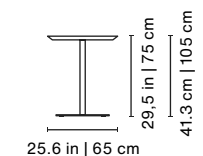

Low

Product weight • Peso del producto
59.5 lb | 27 kg

 28.3x28.3x13.8 in |
72x72x35 cm
81.6 lb | 37 kg

Tall

Product weight • Peso del producto
61.7 lb | 28 kg

 28.3x28.3x13.8 in |
72x72x35 cm
83.8 lb | 38 kg

120 Round • 120 Redonda

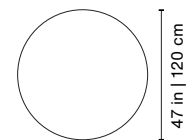
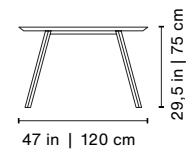

Product weight • Peso del producto
103.6 lb | 47 kg

 50x50x13.8 in |
127x127x35 cm
158.7 lb | 72 kg

rs-barcelona

Ombra

Emiliana Design Studio, 2019

Stool
Taburete



Colours • Colores



White
Blanco



Black
Negro



Red
Rojo



Blue
Azul



Green
Verde



Grey
Gris

Materials

Steel with cataphoretic coating process with micro textured powder coated polyester paint.

Product options

With or without backrest.

Certificates

- ANSI-BIFMA X5.1-2017
- UNE-EN 16139:2013vc2015/L1

Materiales

Acero con cataforesis y pintura poliéster en acabado micro texturado.

Opciones

Con o sin respaldo.

Certificaciones

- ANSI-BIFMA X5.1-2017
- UNE-EN 16139:2013vc2015/L1

Bar

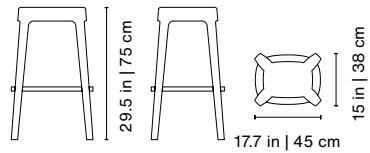

Product weight • Peso del producto 19.6 lb | 8,9 kg



20.1x17.5x42.9 in | 51x44,5x109 cm
22 lb | 10 kg

Counter

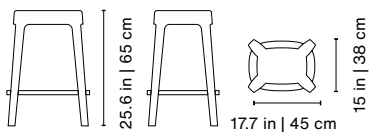

Product weight • Peso del producto 17.9 lb | 8,1 kg



18.9x16.5x26.4 in | 48x42x67 cm
20 lb | 9 kg

Low • Bajo



Product weight • Peso del producto 13.2 lb | 6 kg



17.3x15.1x19.3 in | 44x38,5x49 cm
14.3 lb | 6,5 kg

Bar with backrest • Bar con respaldo

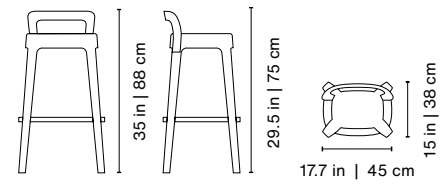

Product weight • Peso del producto 20.9 lb | 9,5 kg



20.1x17.5x42.9 in | 51x44,5x109 cm
23.1 lb | 10,5 kg

Counter with backrest • Counter con respaldo

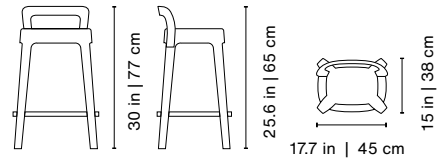

Product weight • Peso del producto 19 lb | 8,7 kg



18.9x16.5x39.4 in | 48x42x100 cm
22 lb | 10 kg

Low with backrest • Bajo con respaldo



Product weight • Peso del producto 14.5 lb | 6,6 kg



17.3x15.1x28 in | 44x38,5x71 cm
15 lb | 7 kg

rs-barcelona

On the Road

Stone Designs, 2008
Bench
Banco



Upholstery • Tapizado



0983



0193



0133



0103

Strap • Cinta



Grosella



Roto



Royal

Materials

Structure: Cross-ply beech base with solid beech legs.
Upholstery: Uniform Mélange from Kvadrat (68% wool, 22% nylon and 10% polyester).
Strap: 100% polyester.
Stuffing: Mix of natural and synthetic fibres.

Materiales

Estructura: Base en contrachapado de madera de haya y patas de haya macizas.
Tapizado: Uniform Mélange de Kvadrat (68% lana, 22% nylon y 10% poliéster).
Cinta: 100% poliéster.
Relleno: Mezcla de fibras naturales y sintéticas.

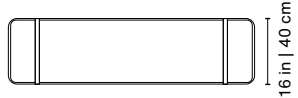
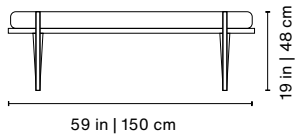

Product weight • Peso del producto 28.7 l | 13 kg

60.2x16.9x16.5 in | 152x43x42 cm
33 lb | 15 kg

rs-barcelona

Mon Oncle

Mermelada Estudio, 2014
Barbecue
Barbacoa



Colours • Colores



Blue
Azul



Green
Verde



Grey
Gris

Materials

Structure: Steel with cathophoretic coating process and micro textured powder coated polyester paint.
Grill: Stainless steel.
Inside tray: Stainless steel.
Strap: Fabric and leather handle.

Materiales

Estructura: Acero con cataforesis y pintura poliéster con acabado micro texturado.
Parrilla: Acero inoxidable.
Bandeja interior: Acero inoxidable.
Cinta: Tela y asa de piel.

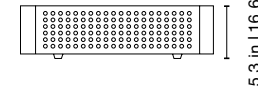
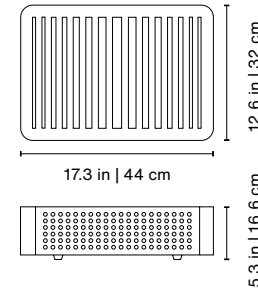

Product weight • Peso del producto 13.9 lb | 6,3 kg

19.7x15.6x7.1 in | 50x39x18 cm
17.6 lb | 8 kg

rs-barcelona

Wall Champions 1

Rafael Rodriguez, 2007

Coat hook
Colgador



Materials
Cast aluminium.

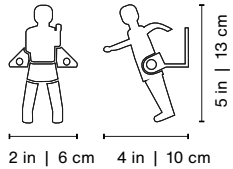

Materiales
Aluminio fundido.

Product weight • Peso del producto 0.7 lb | 0,3 kg

3.2x6.3x4.3 in | 8x16x11 cm
0.7 lb | 0,3 kg

Wall Champions 4

Rafael Rodriguez, 2007

Coat rack
Colgador



Materials
Player: Cast aluminium.
Rod: Satin finish steel and wooden handle.

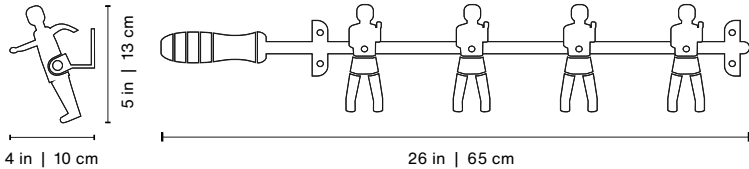

Materiales
Jugador: Aluminio fundido.
Barra: Acero en acabado satinado y mango de madera.

Product weight • Peso del producto 4.5 lb | 2 kg

28x6.3x4.3 in | 71x16x11 cm
5 lb | 2,3 kg



Make it extraordinary.



Customisation • Customización

Customisation is one of our brand values. We know how important it is to be flexible to fit the needs and requirements of each project and client, and add that touch of distinction that makes it so special. Turn our products into exclusive pieces by customising them with the options we offer you.

La personalización es uno de los valores de nuestra marca. Sabemos lo importante que es adaptarse a las necesidades y exigencias de cada proyecto y cliente y añadir ese toque de distinción que lo hace tan especial. Convierte nuestros productos en piezas exclusivas personalizándolas con las opciones que te proponemos.

Football and Dining Tables • Futbolines y Futbolines Mesa

Once you have chosen the football table or the football dining table that suits your project, it is time to make it unique.

Una vez elegido el modelo de futbolín o futbolín-mesa que se acomoda a las características de tu proyecto, llega el momento de hacerlo único.

Standard customisation

Customisation options included when you order a football table.

Choose your lineup

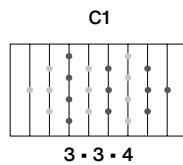

Elige tu alineación

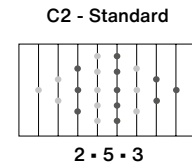

Players • Gender • Skin colour

Choose the player, gender and skin colour that best suits your kind of play.

Jugadores • Género • Color de piel

Elige el tipo de jugadores, género y color de piel que se adapta a tu juego.

Two feet
Dos pies

One foot
Un pie

All boys
Todo chicos

All girls
Todo chicas

Girls vs. Boys
Chicos vs. Chicas

Mixed teams
Equipos mixtos

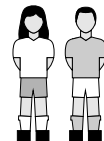
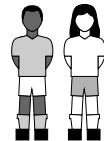
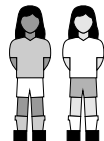
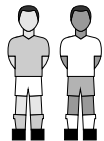
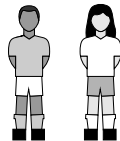

Girl players only available with two feet.

Jugadoras chicas solo disponibles con dos pies.

Custom

The following options have an extra cost informed in our price list and customisation guide.

Customización

Las siguientes modificaciones tienen un coste extra que se indica en nuestras tarifas y en la guía de customización.

The colour you wish.

Choose the specific RAL colour for the steel structure (powder coated polyester paint).

El color deseado.

Elige el color RAL concreto para la estructura metálica (pintura poliéster en polvo).



The brand, a distinguishing feature.

Include the logo on the outer goal ends (vinyl).

La marca, un signo de identidad.

Incorpora el logo en los laterales cortos del futbolín (vinilo).

Add colour to the legs.

Change the iroko wooden legs to walnut or oak wood or add colour without losing its natural appearance (stained).

Dale color a las patas.

Cambia las patas de madera de iroko por nogal o roble o añádeles color sin que pierda su aspecto natural (lacado).

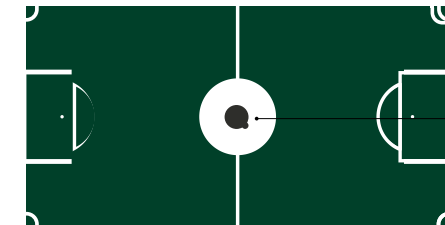

Add the logo in the center of the field (vinyl).

Incluye el logo en el centro del campo (vinilo).

Include the logo on players chest (screen printing).

Añade el logo en el pecho de los jugadores (serigrafía).

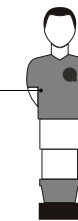

Add numbers and names on players back (vinyl).

Pon números y nombres en la espalda de los jugadores (vinilo).

Special players customisation examples.

Ejemplos de customizaciones especiales de jugadores.



Ping Pong Tables • Mesas de Ping-Pong

RS Barcelona ping pong tables are much more than just a playing pitch. They are a gathering point between playability and design, with a high aesthetic value to which you can add your personal touch.

The following options have an extra cost informed in our price list and customisation guide.

Las mesas de ping-pong RS Barcelona son mucho más que un terreno de juego. Son un punto de encuentro entre jugabilidad y diseño, con un alto valor estético al que puedes añadir tu toque personal.

Las siguientes modificaciones tienen un coste extra que se indica en nuestras tarifas y en la guía de customización.

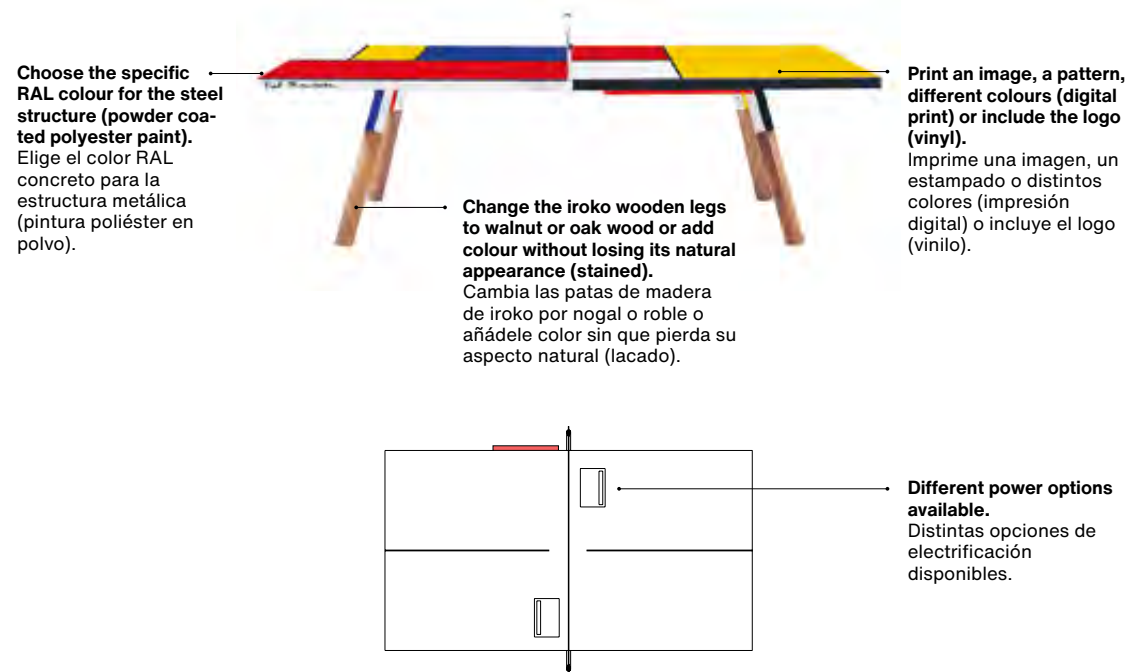

Pool Tables • Billares

Pool is an elegant and precision game. We can emphasize its excellence by customising certain details of the piece so that it blends perfectly with the environment and shows all its appeal.

The following options have an extra cost informed in our price list and customisation guide.

El billar es un juego elegante y de precisión. Una precisión que podemos enfatizar customizando ciertos aspectos de la pieza para que se mimetice con el espacio y luzca en toda su intensidad y atractivo.

Las siguientes modificaciones tienen un coste extra que se indica en nuestras tarifas y en la guía de customización.



Design & colours • Diseño y colores

The colours and textures used by RS Barcelona express timelessness and harmony. With striking purity and sensuality, they enhance the beauty of our items, allowing you to combine tones and create your own colour palette.

Los colores y texturas RS Barcelona hablan de atemporalidad y armonía. Emocionan con su pureza y sensualidad y realzan la belleza de nuestras piezas, permitiendo mezclar tonalidades y crear tu propia paleta de color.

Metal

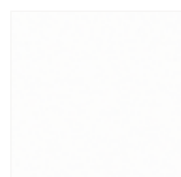

White
Blanco
RAL 9016
Textured



Black
Negro
RAL 9005
Textured



Red
Rojo
RAL 3020
Textured



Blue
Azul
RAL 5001
Textured



Green
Verde
NCS S7005-B80G
Textured

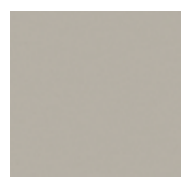

Grey
Gris
RAL 7044
Textured



Yellow
Amarillo
RAL 1016
Textured



Terracotta
Terracota
NCS S 4040Y80R
Textured



Inox

Wood & HPL • Madera & HPL



Iroko Wood
Madera de Iroko



Walnut Wood
Madera de Nogal

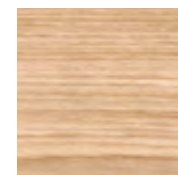

Oak Wood
Madera de Roble

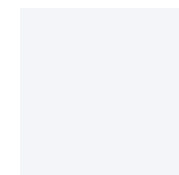

White HPL
HPL Blanco

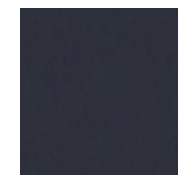

Black HPL
HPL Negro



Green HPL
HPL Verde



Grey HPL
HPL Gris

Textile • Textil

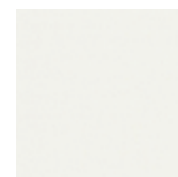

Natural

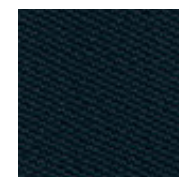

Black
Negro

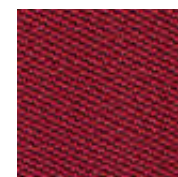

Burgundy
Granate



Grey Blue
Azul Gris

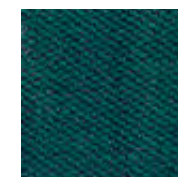

Green
Verde

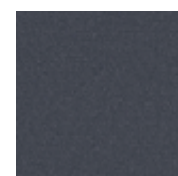

Carbon
Carbón

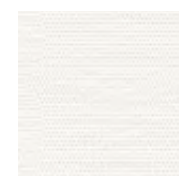

White
Blanco



Dark Taupe



0983

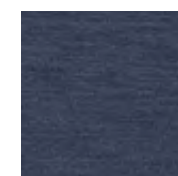

0193



0103



0133

Design & quality • Diseño y calidad

Top quality, the ability to withstand intensive use and durability. These are concepts we take for granted when looking for an item to incorporate in our lives. Durability is the cornerstone of all the decisions we make in our product development process. That's why we select top-quality materials and manufacturing processes that guarantee the optimal toughness and longevity of our products.

We always use raw materials that meet the highest standards of quality, sustainability and social responsibility. We take the greatest care in sourcing our materials, ensuring that they can be subsequently transformed and reused, and that they don't contain any chemical components harmful to the ecosystem. This is crucial in order to create and manufacture in a way that respects people's health and the environment.

The RS Barcelona Commitment, along with the quality seals and labels of the materials we use to manufacture our items, are all displayed on our website.

rs-barcelona.com/en/about-us/sustainability/

Máxima calidad, resistencia al uso intenso y larga duración. Son conceptos que damos por hecho cuando buscamos una pieza que integrar a nuestra vida. La durabilidad es el eje sobre el que basamos todas las decisiones que tomamos en el desarrollo de nuestras piezas. Por ello, seleccionamos materiales de alta calidad y procesos de fabricación que garanticen la mayor resistencia y longevidad a nuestros productos.

Trabajamos siempre con materias primas que cumplan con los más altos estándares de calidad, sostenibilidad y responsabilidad social. Y conocer su procedencia es nuestro modo de garantizar que pueden ser transformados y reutilizados, y que no contienen componentes químicos nocivos para el ecosistema. Para crear y fabricar de forma respetuosa con la salud de las personas y el medio ambiente.

Consulta en nuestra web, el Compromiso RS Barcelona y los sellos y etiquetas de calidad de los materiales que usamos en la producción de nuestras piezas.

rs-barcelona.com/es/sobre-nosotros/sostenibilidad/

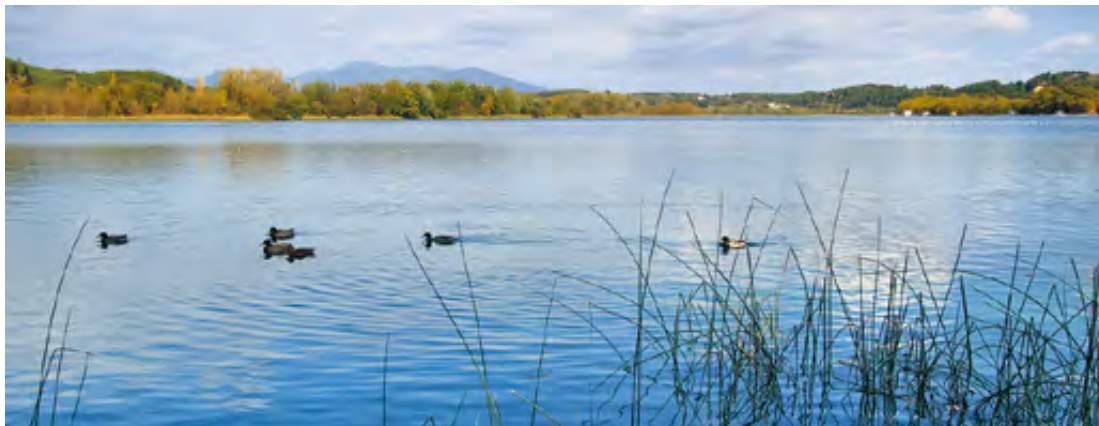

RS Barcelona Book

Copyright © 2021 RS Barcelona

Art direction & graphic design · Dirección de arte y diseño gráfico

Aimée Duchamp

Copywriting · Redacción

María Carrasco

Photography · Fotografía

Meritxell Arjalaguer

Joan Cabacés

Carlos Iglíki

Blanca Muntadas

Creative production consultant · Consultora creativa en producción impresa

I am Nuria

iamnuria.com

Printed by · Impreso por

Impressus

impressus.es

This book was printed on paper certified by · Este libro ha sido impreso en papel certificado por:

FSC® FSC-C110625



Printed in · Impreso en Barcelona

All rights reserved · Todos los derechos reservados

Acknowledgments · Agradecimientos

Genialidades

Hotel Alexandra

Hotel Seventy

Rilke

Head Office & Showroom

C. Còrsega, 365

08037, Barcelona

Spain

Phone: +34 936589503

E-mail: info@rs-barcelona.com

Factory

C. Ferrocarril, 16

08840, Viladecans (Barcelona)

Spain

Warehouse

C. Noi del sucre, 3

08840, Viladecans (Barcelona)

Spain

RS Barcelona LLC (USA)

E-mail: andrea@rs-barcelona.com

Phone: +1 424 249 9646

Los Angeles, CA

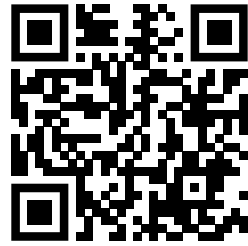

rs-barcelona.com

Scann this code and find out our intense living products.

f @ in p v